

Skriv ordenes forlyd i kasserne

Se på billedet, sig ordet højt og skriv ordets forlyd i kassen.

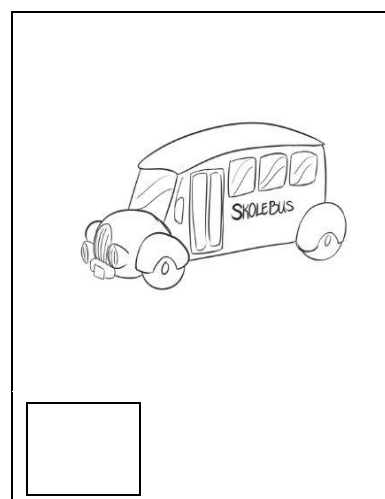
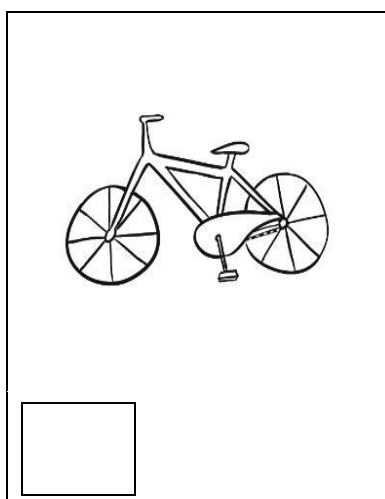
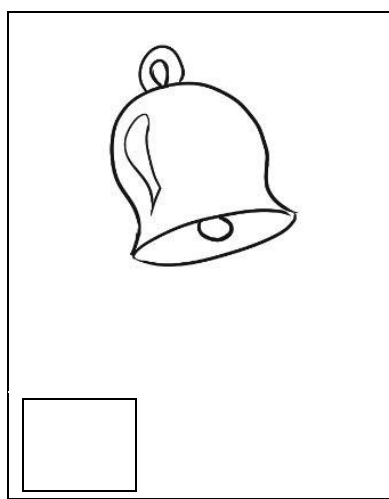
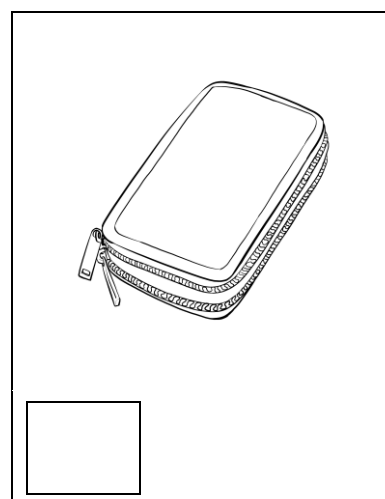
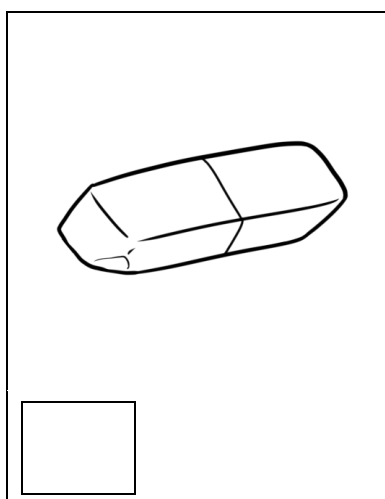
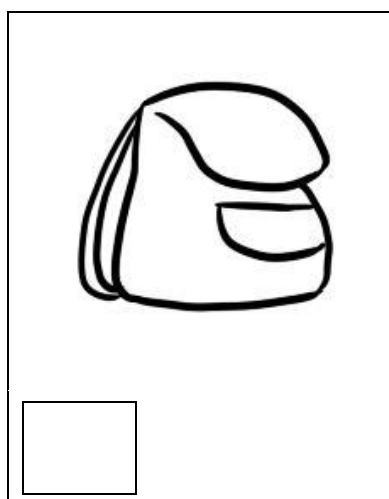
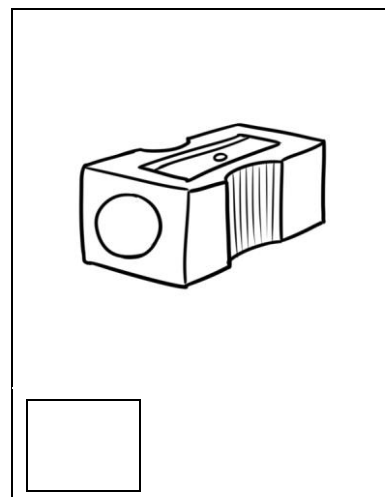
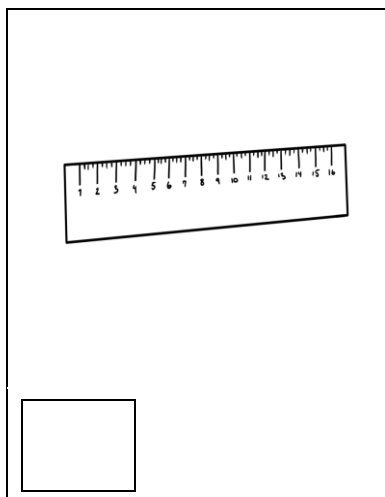
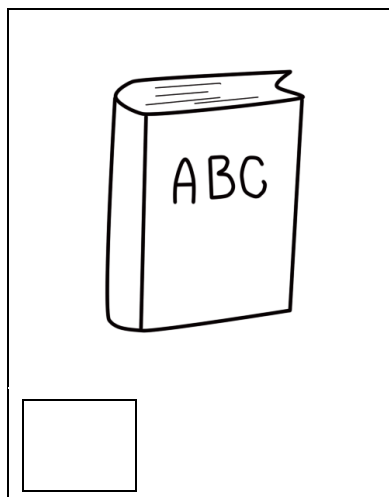

Skriv ordenes forlyd i kasserne

LØSNING

Se på billedet, sig ordet højt og skriv ordets forlyd i kassen.

