

Huskespil: Skole

Vend brikkerne og find de ord og billeder der passer sammen.

penalhus

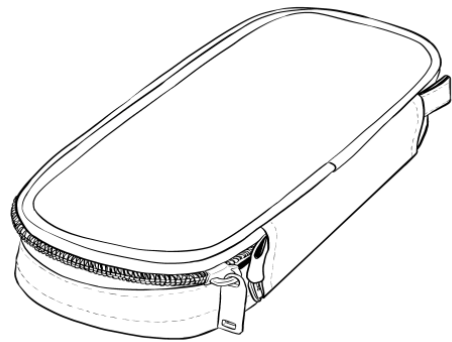

viskelæder

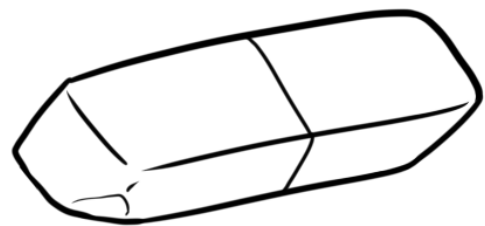

lineal

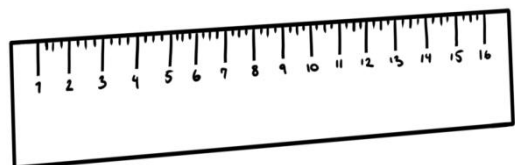

Huskespil: Skole

Vend brikkerne og find de ord og billeder der passer sammen.

kost

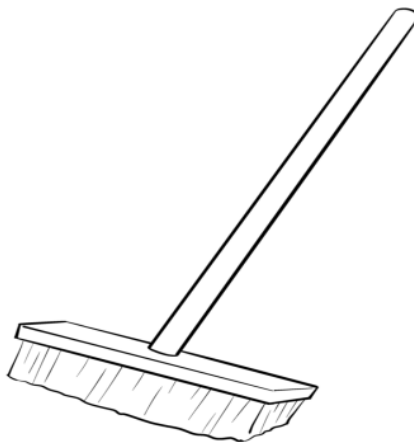

fejebakke

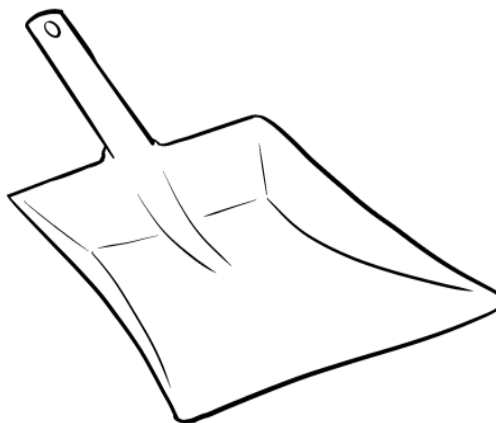

bord

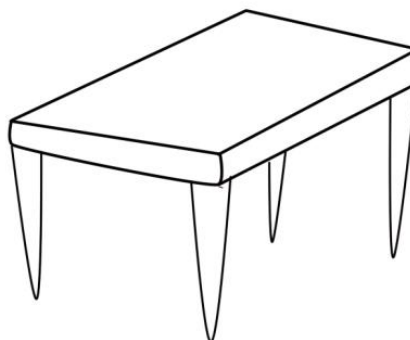

Huskespil: Skole

Vend brikkerne og find de ord og billeder der passer sammen.

skole-bus

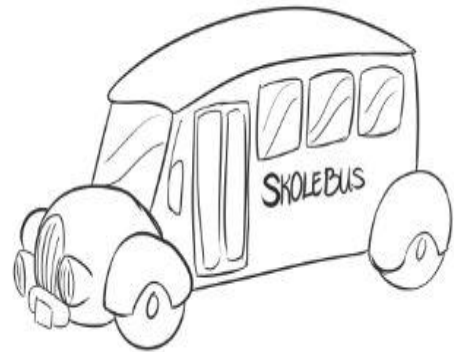

mobil-
telefon

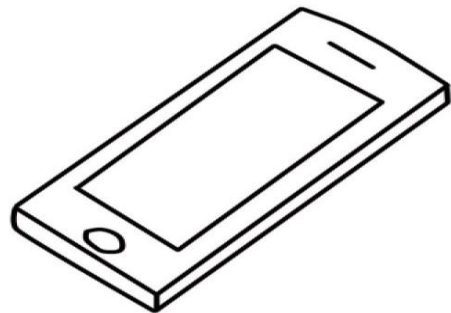

blyant-
spidser

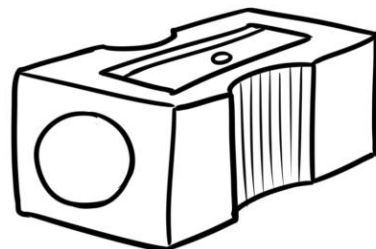

Huskespil: Skole

Vend brikkerne og find de ord og billeder der passer sammen.

bøger



taske



vinkelmåler

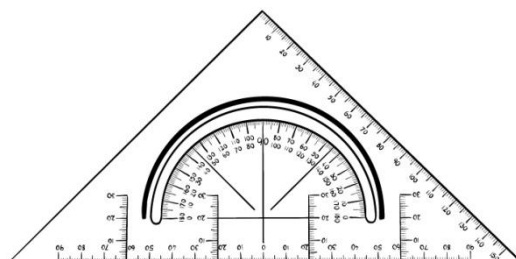

Huskespil: Skole

Vend brikkerne og find de ord og billeder der passer sammen.

passer

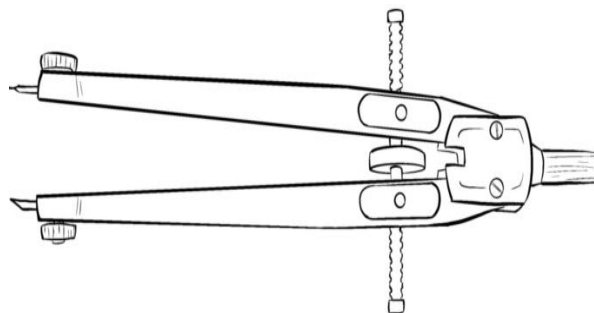

klokke



blyant

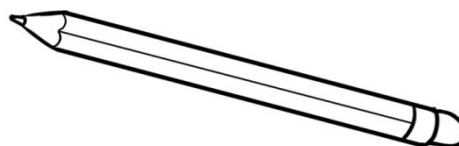

Huskespil: Skole

Vend brikkerne og find de ord og billeder der passer sammen.

farve-
blyanter

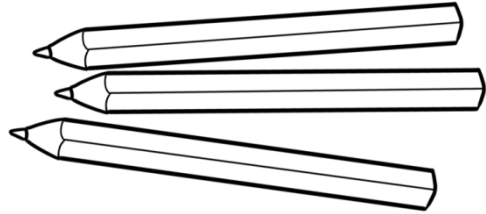

tavle

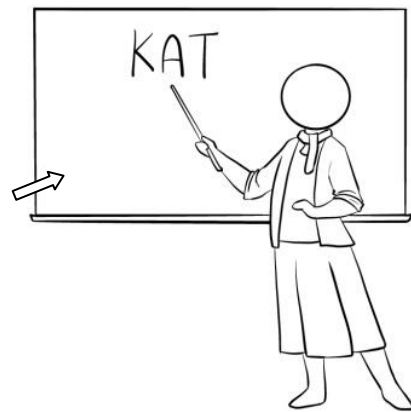

klasse-
værelse

