

Find **A** lyden

Sig ordet.

Lyt til **A** lyden.

Sæt kryds ved **A** lyden i begyndelsen, i midten eller til sidst i ordet.

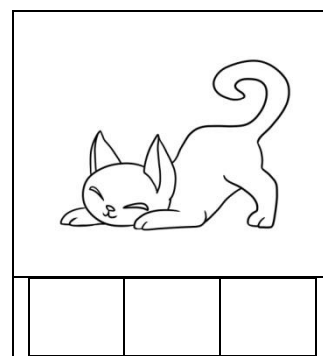
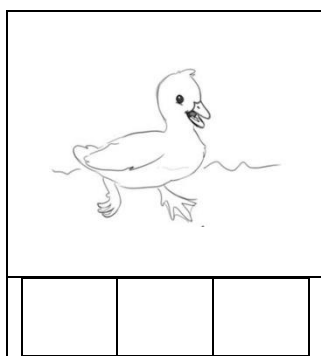
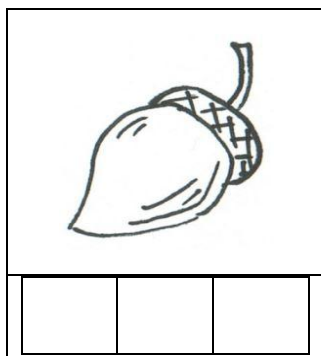
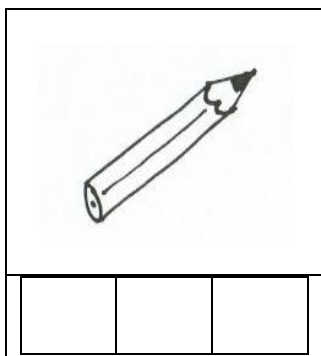
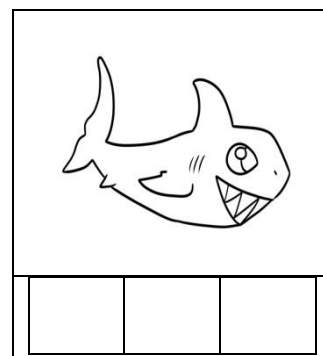
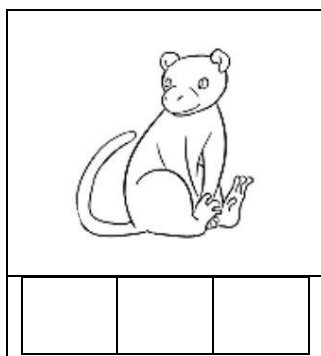

Find **A** lyden **LØSNING**

Sig ordet.

Lyt til **A** lyden.

Sæt kryds ved a lyden i begyndelsen, i midten eller til sidst i ordet.

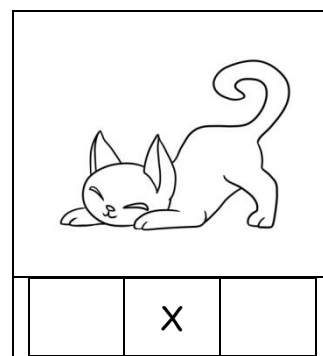
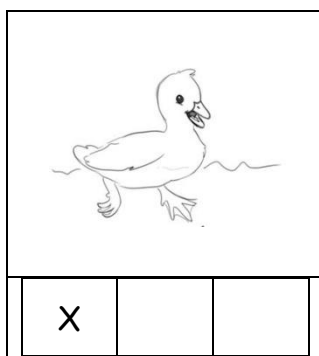
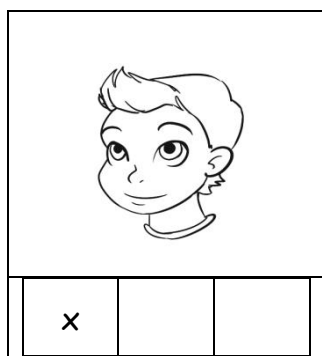
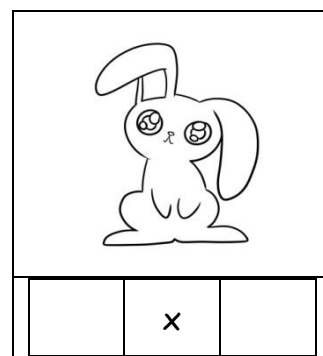
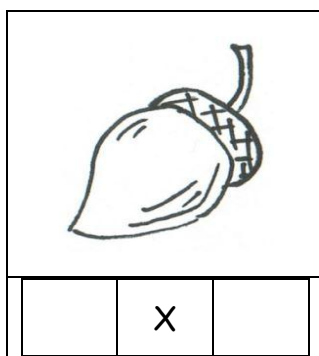
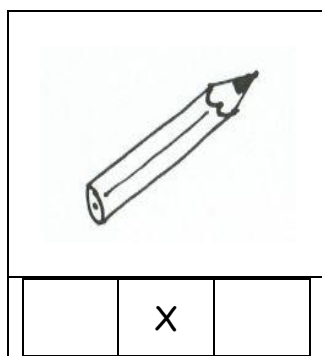
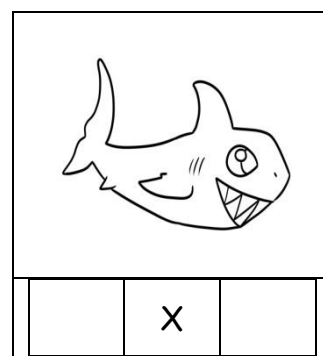
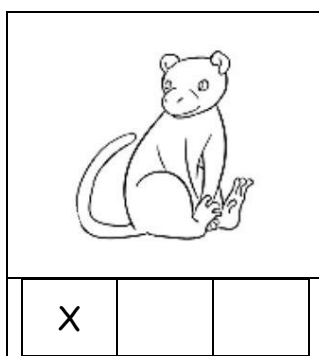
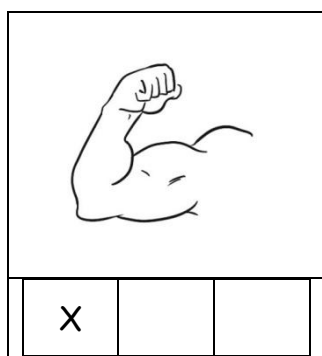

Find B lyden

Sig ordet.

Lyt til B lyden.

Sæt kryds ved B lyden i begyndelsen, i midten eller til sidst i ordet.

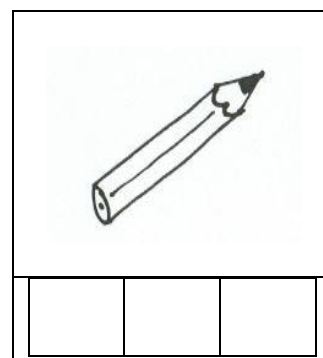
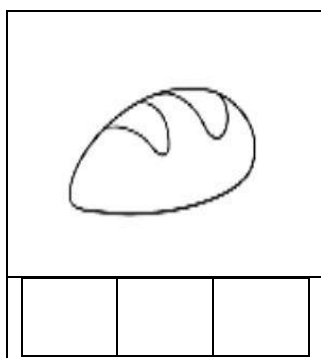
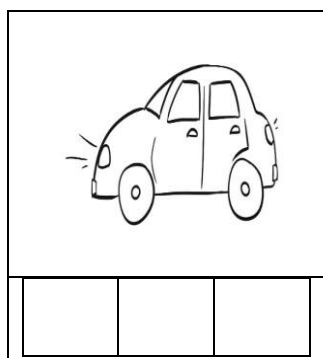
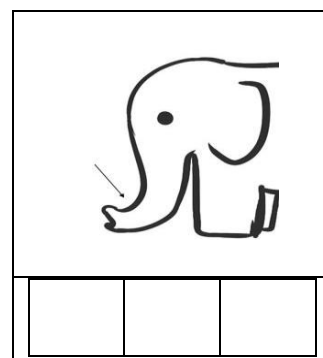
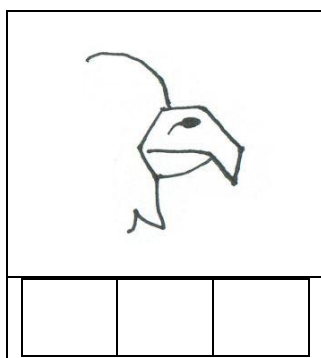
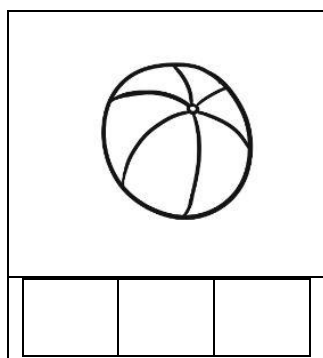
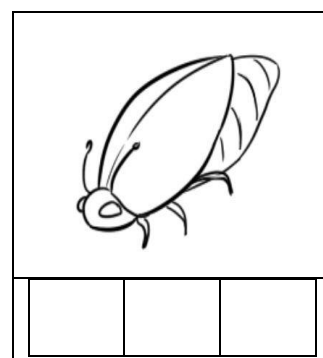
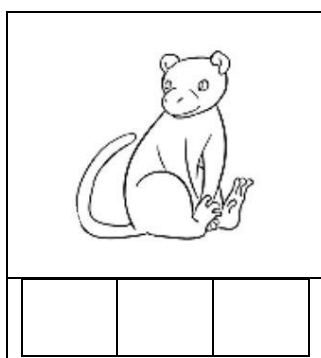

Find B lyden **LØSNING**

Sig ordet.

Lyt til B lyden.

Sæt kryds ved a lyden i begyndelsen, i midten eller til sidst i ordet.

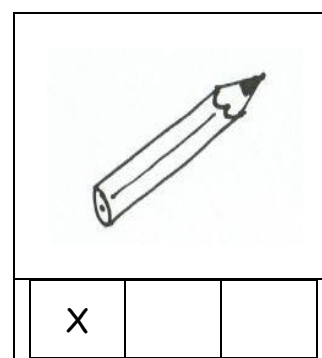
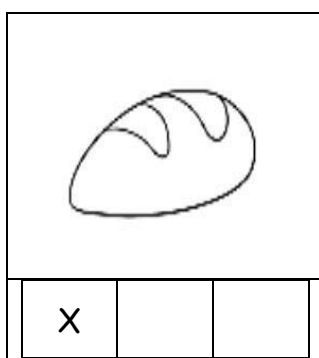
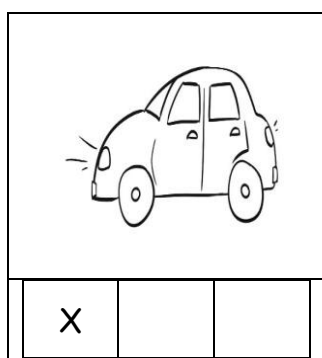
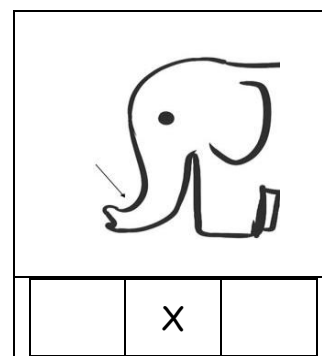
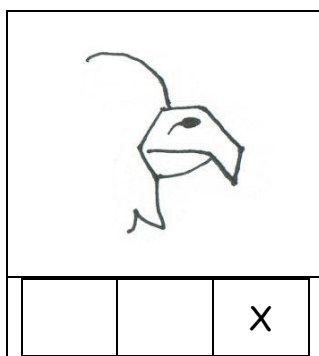
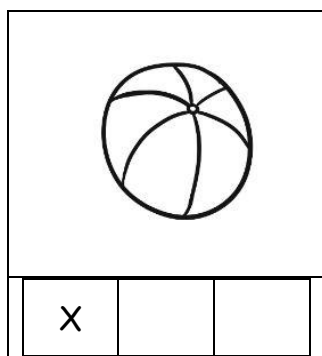
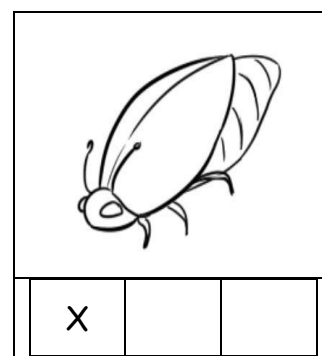
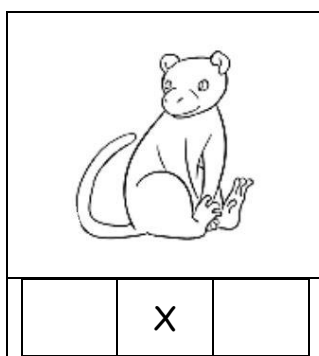
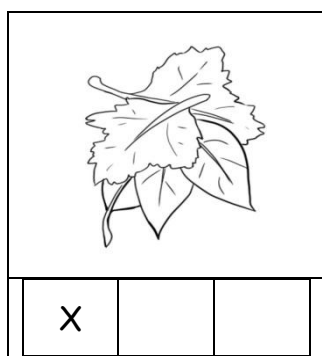

Find C lyden

Sig ordet.

Lyt til C lyden.

Sæt kryds ved C lyden i begyndelsen, i midten eller til sidst i ordet.

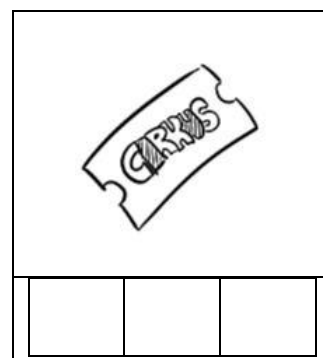
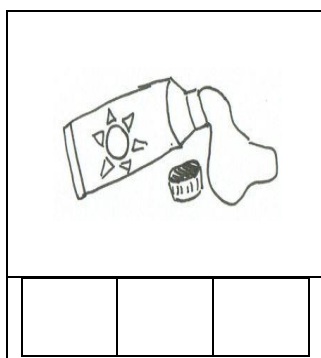
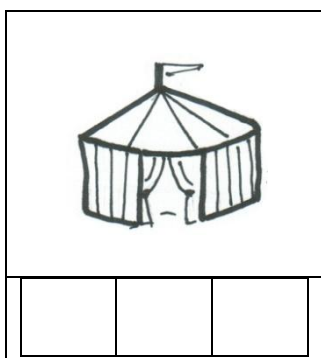
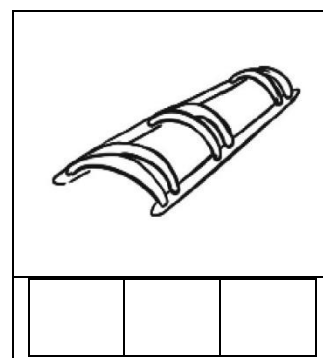
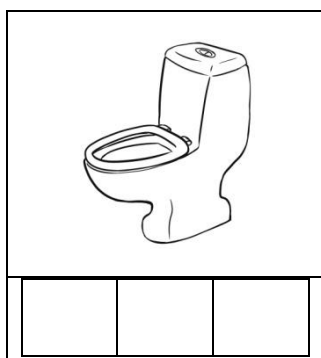
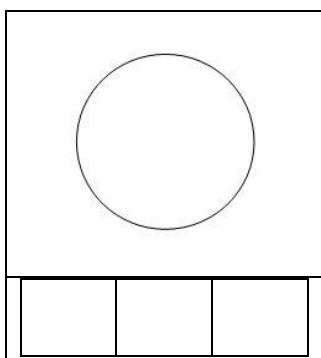
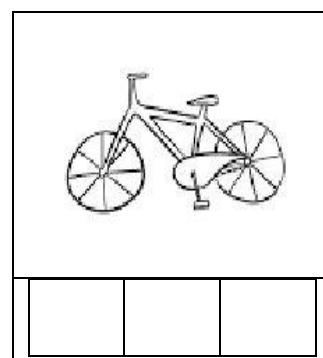
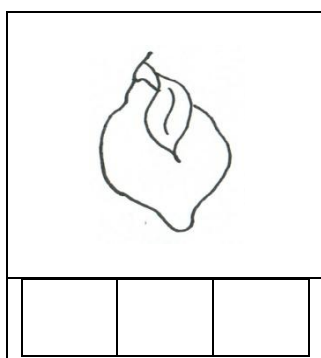
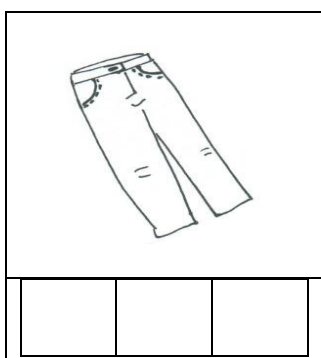

Find C lyden **LØSNING**

Sig ordet.

Lyt til C lyden.

Sæt kryds ved a lyden i begyndelsen, i midten eller til sidst i ordet.

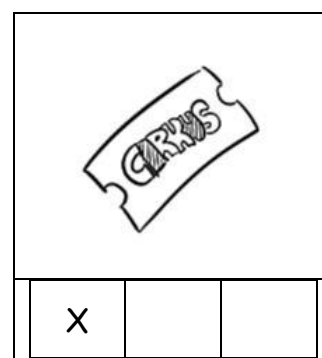
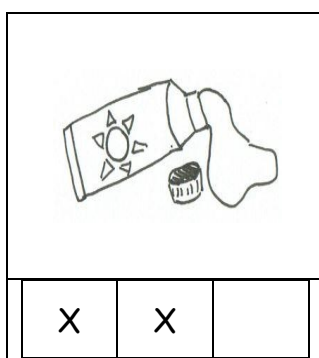
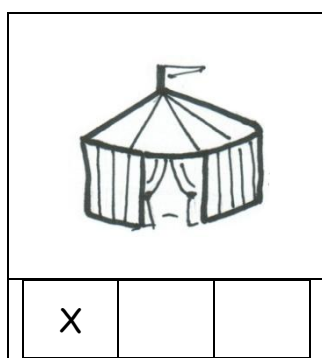
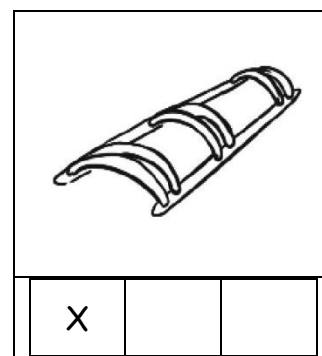
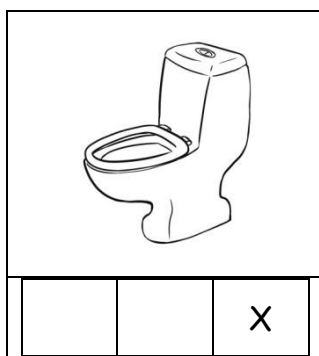
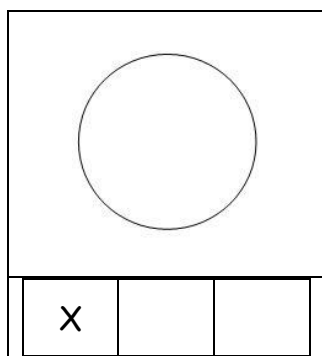
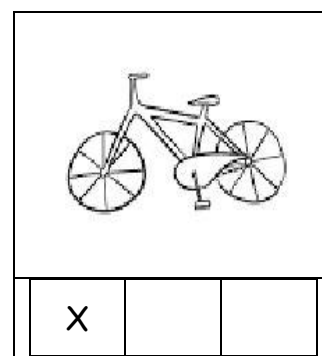
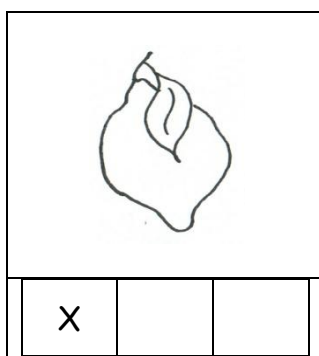
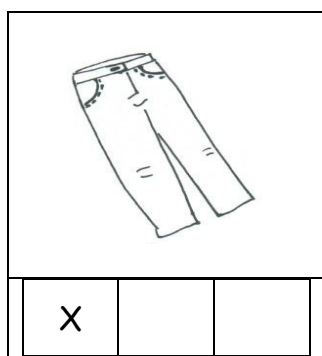

CREAM

SOLDREAM

Find D lyden

Sig ordet.

Lyt til D lyden.

Sæt kryds ved D lyden i begyndelsen, i midten eller til sidst i ordet.

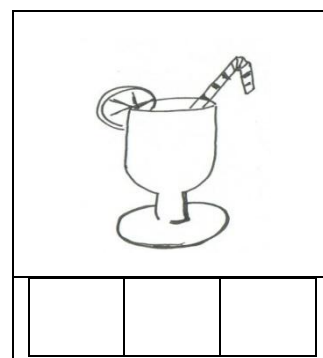
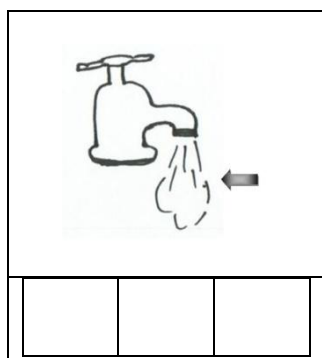
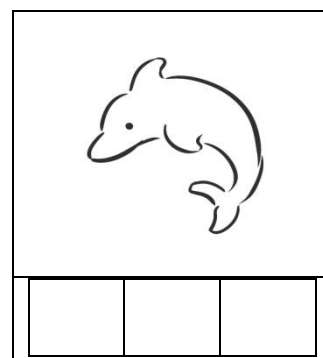
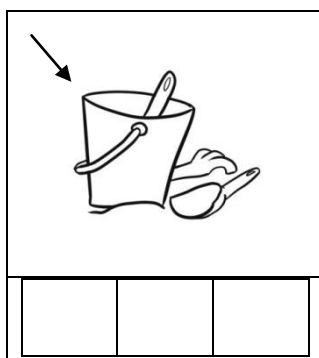
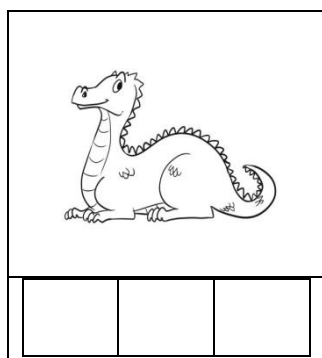
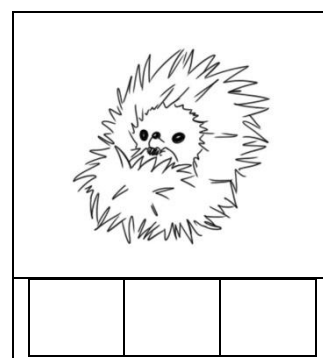
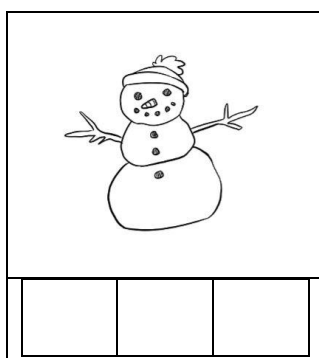
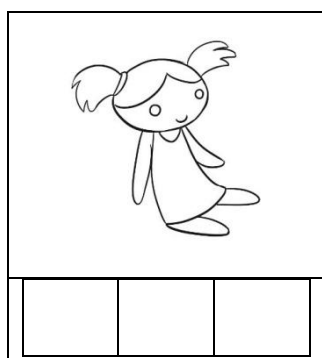

Find D lyden **LØSNING**

Sig ordet.

Lyt til D lyden.

Sæt kryds ved a lyden i begyndelsen, i midten eller til sidst i ordet.

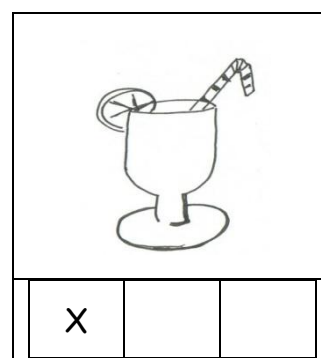
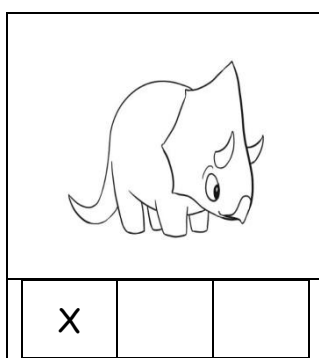
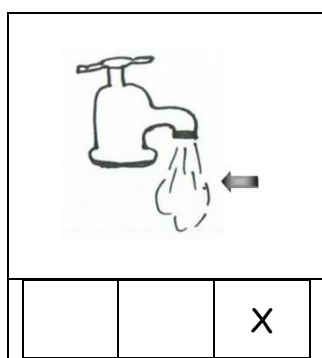
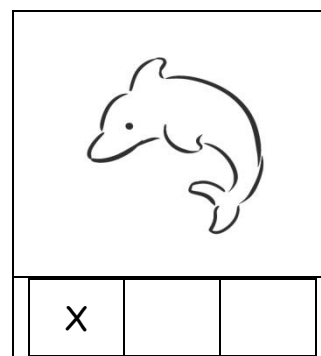
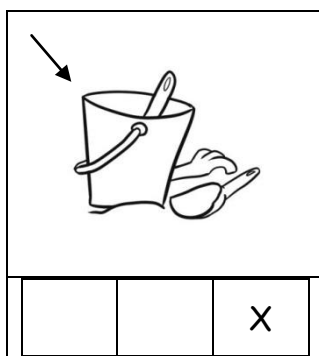
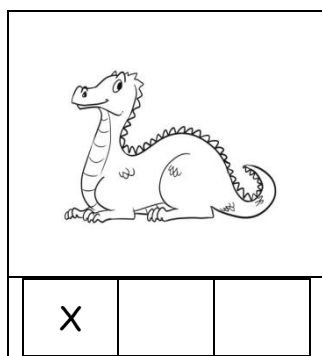
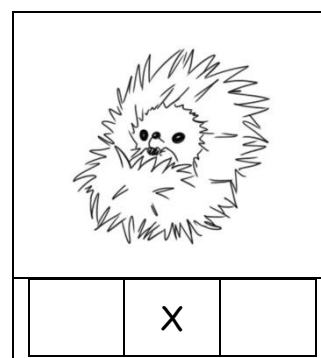
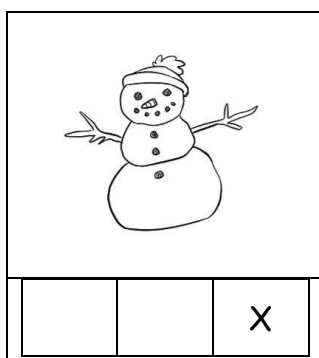
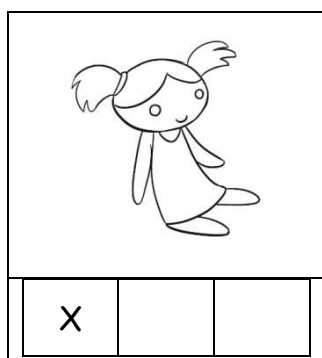

Find E lyden

Sig ordet.

Lyt til E lyden.

Sæt kryds ved E lyden i begyndelsen, i midten eller til sidst i ordet.

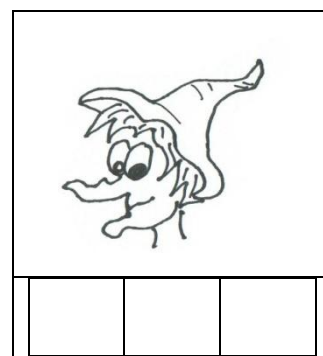
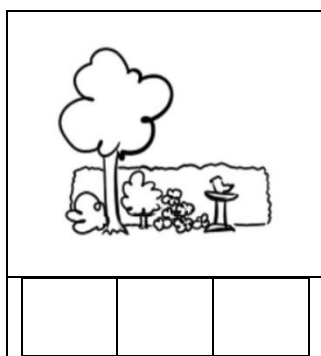
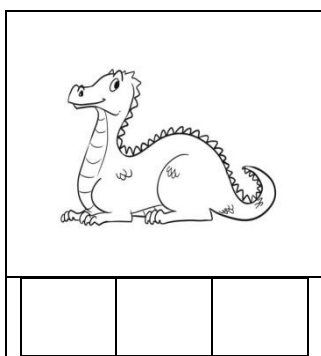
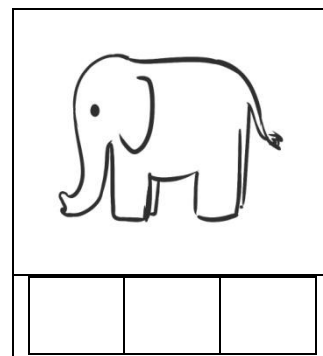
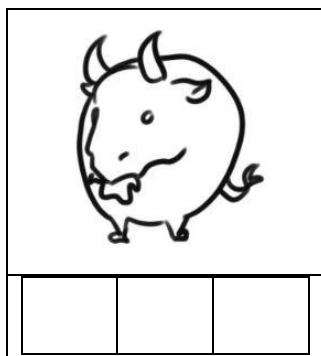
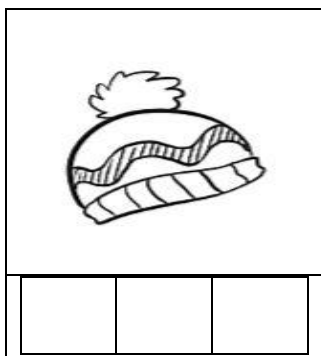
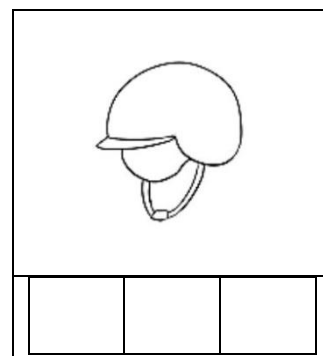
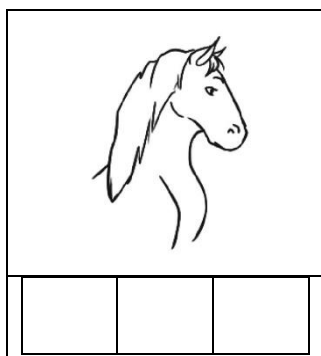
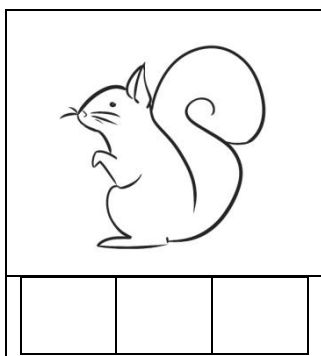

Find E lyden LØSNING

Sig ordet.

Lyt til E lyden.

Sæt kryds ved E lyden i begyndelsen, i midten eller til sidst i ordet.

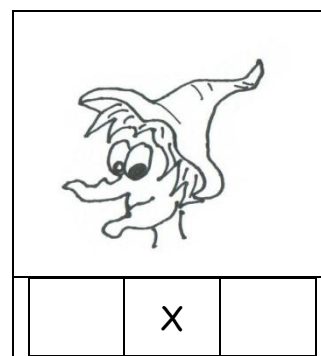
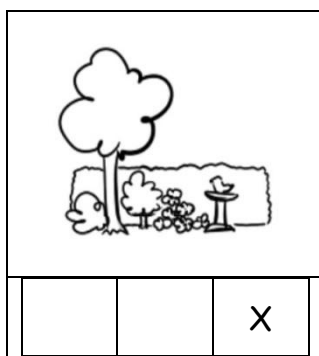
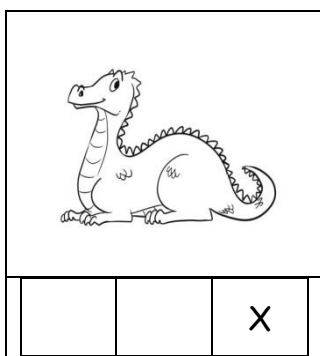
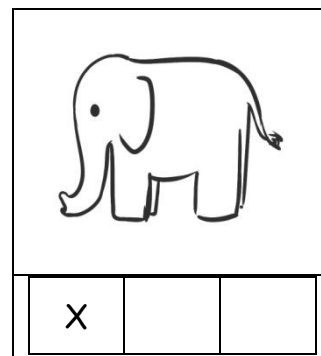
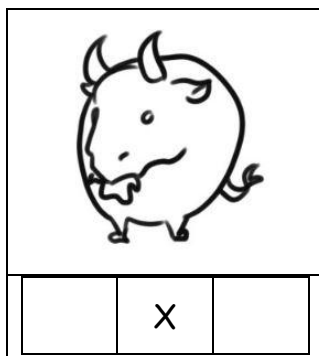
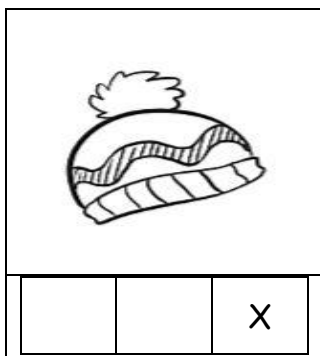
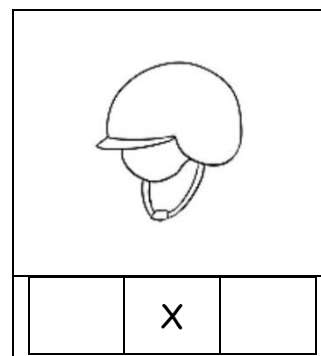
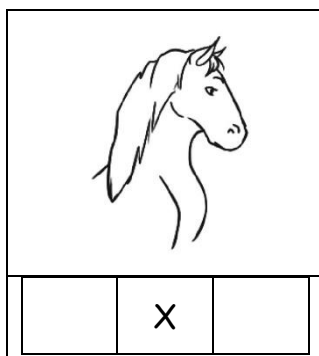
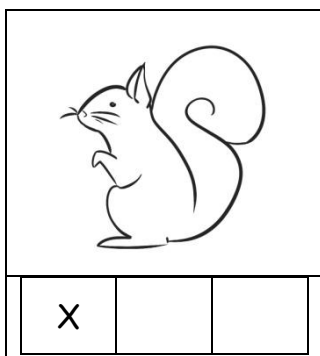

Find F lyden

Sig ordet.

Lyt til F lyden.

Sæt kryds ved F lyden i begyndelsen, i midten eller til sidst i ordet.

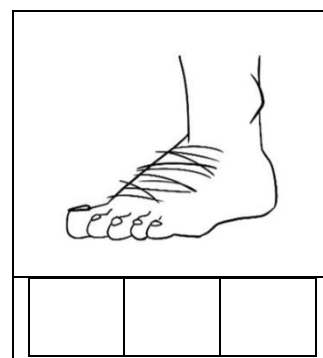
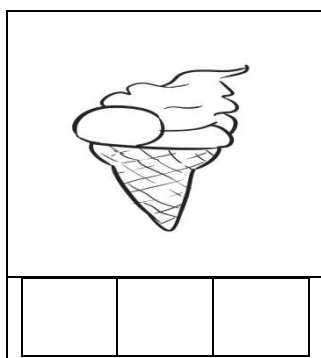
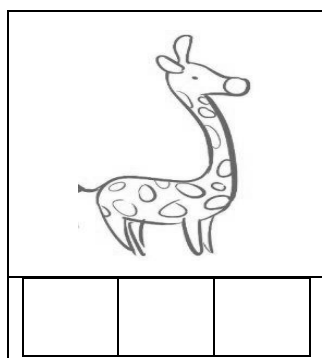
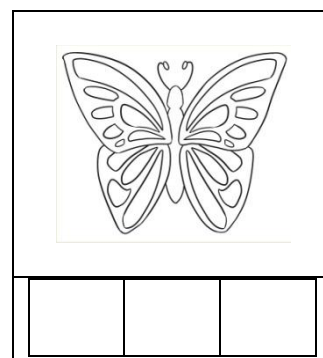
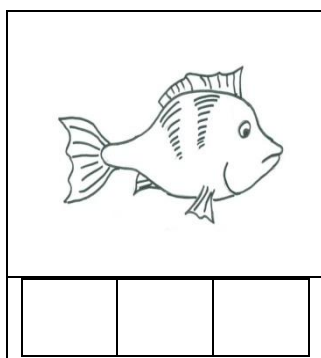
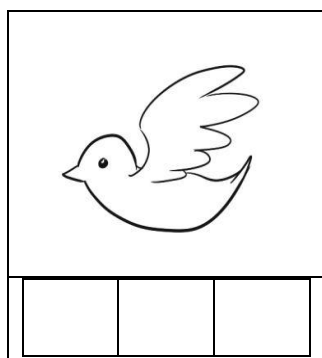
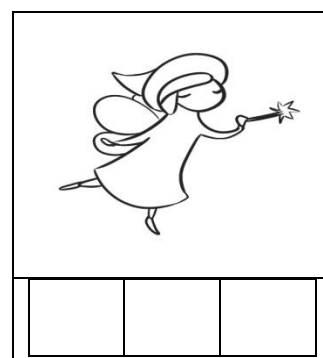
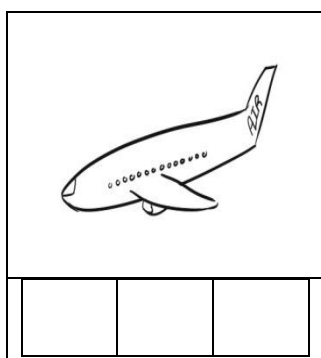
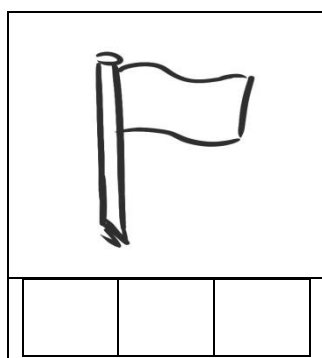

Find F lyden **LØSNING**

Sig ordet.

Lyt til F lyden.

Sæt kryds ved F lyden i begyndelsen, i midten eller til sidst i ordet.

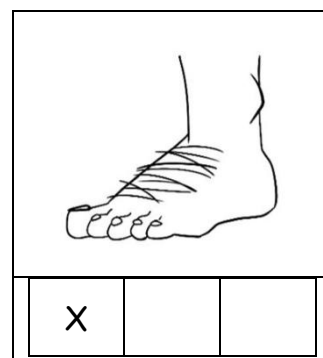
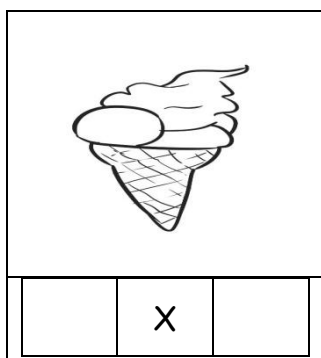
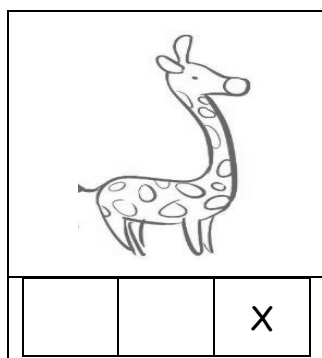
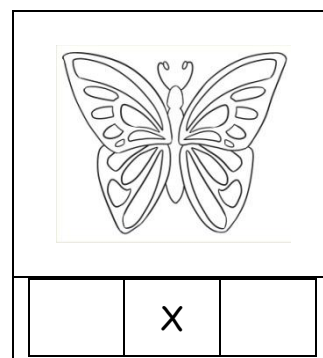
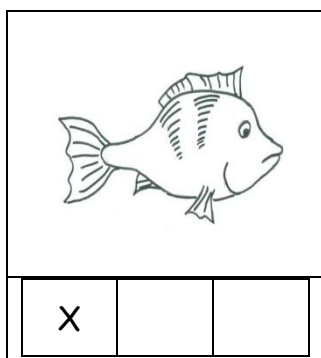
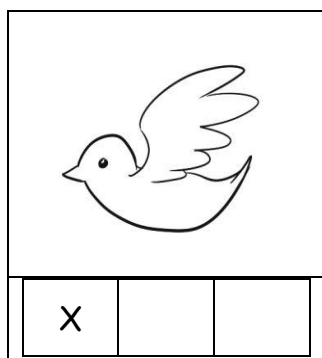
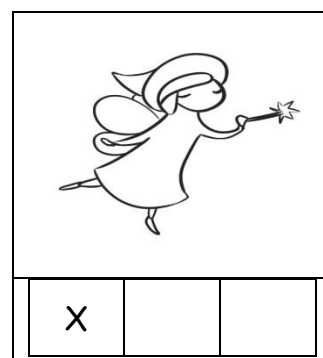
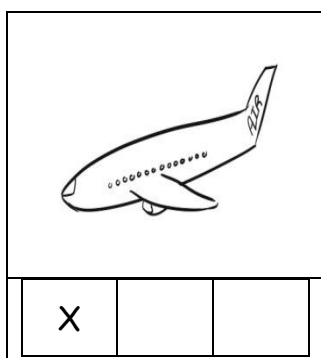
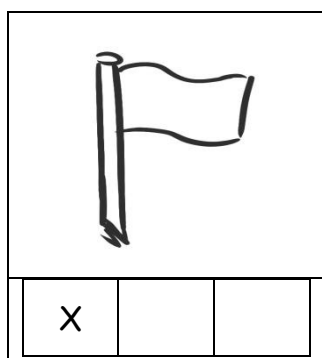

Find G lyden

Sig ordet.

Lyt til G lyden.

Sæt kryds ved G lyden i begyndelsen, i midten eller til sidst i ordet.

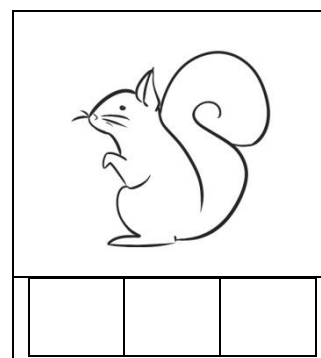
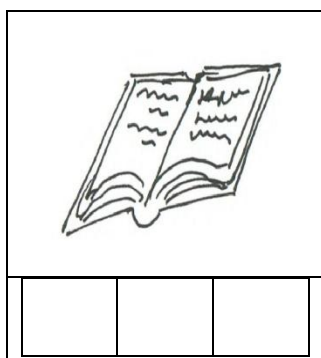
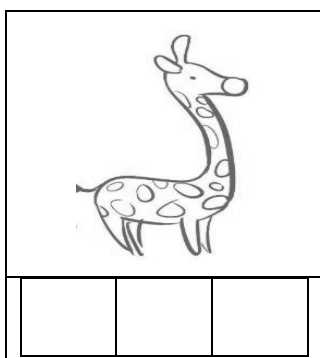
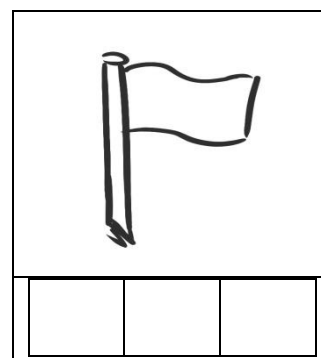
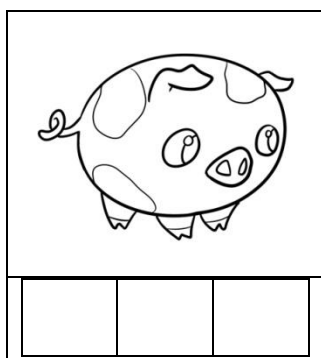
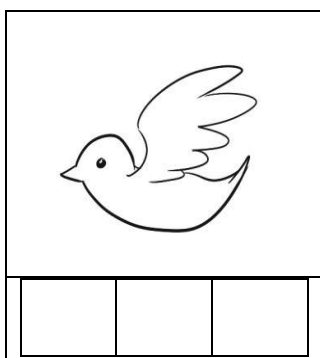
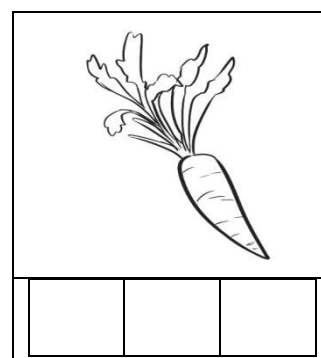
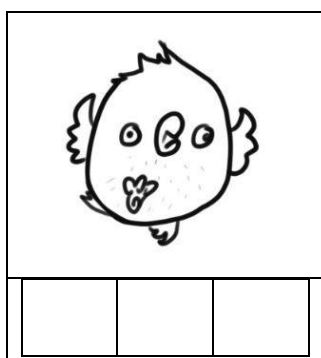
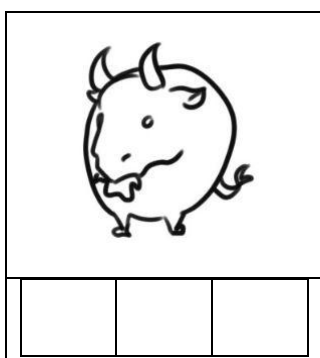

Find G lyden **LØSNING**

Sig ordet.

Lyt til G lyden.

Sæt kryds ved G lyden i begyndelsen, i midten eller til sidst i ordet.

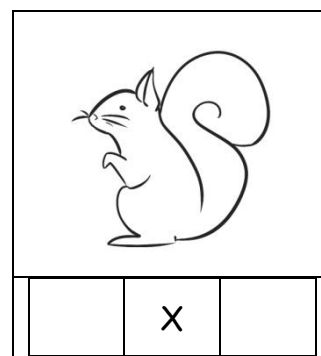
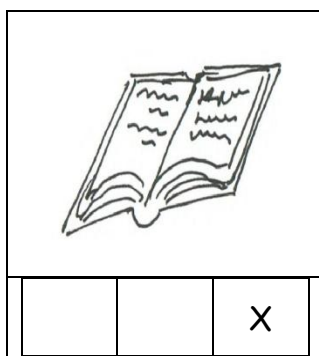
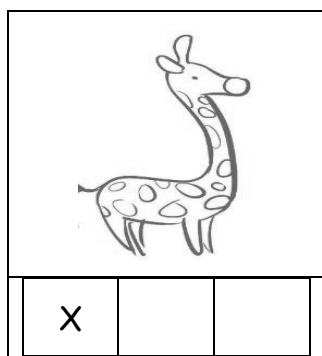
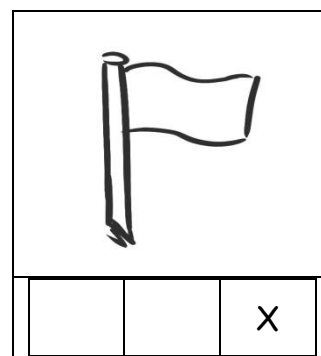
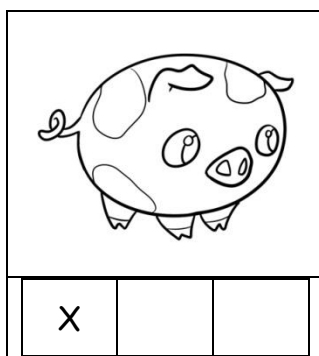
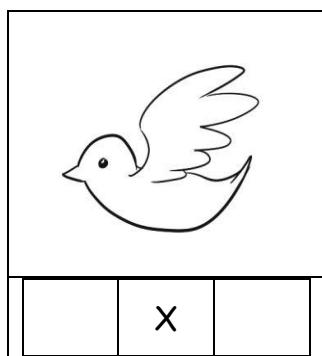
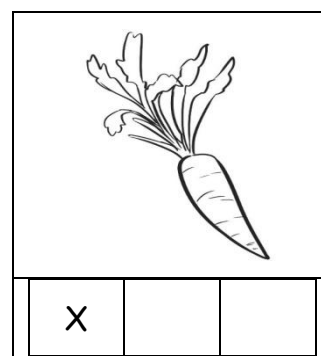
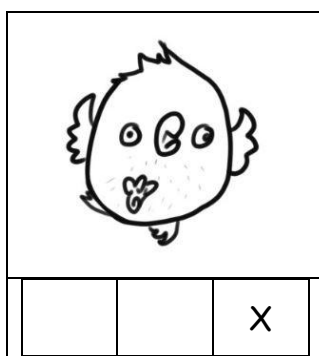
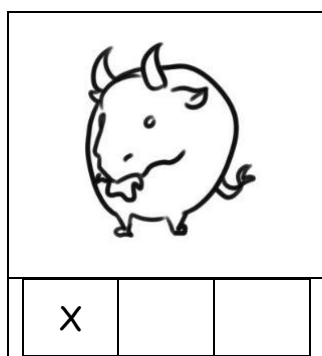

Find H lyden

Sig ordet.

Lyt til H lyden.

Sæt kryds ved H lyden i begyndelsen, i midten eller til sidst i ordet.

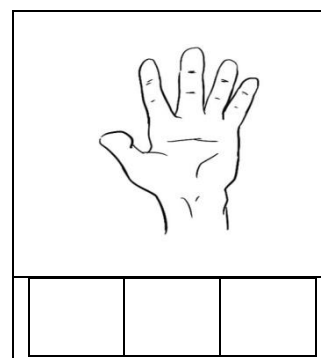
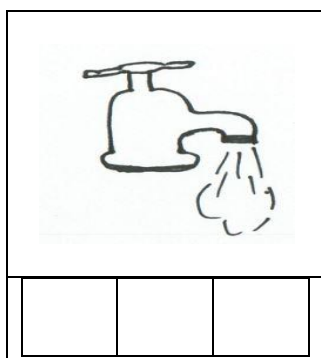
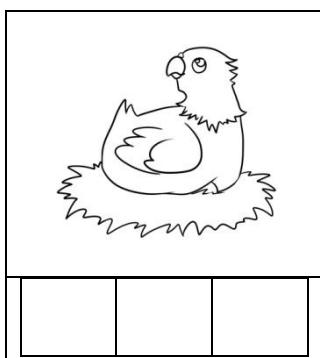
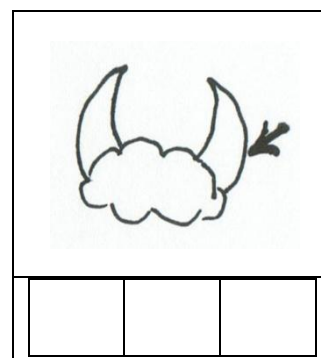
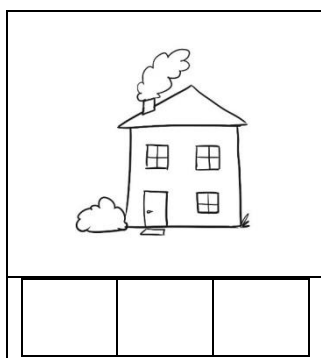
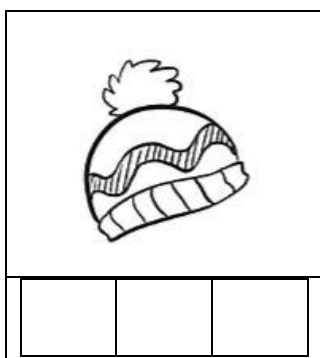
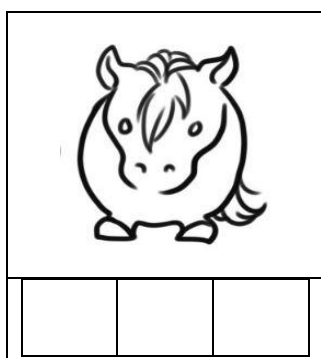
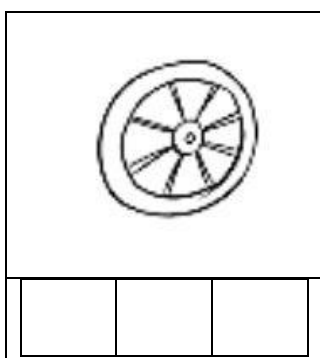

Find H lyden **LØSNING**

Sig ordet.

Lyt til H lyden.

Sæt kryds ved H lyden i begyndelsen, i midten eller til sidst i ordet.

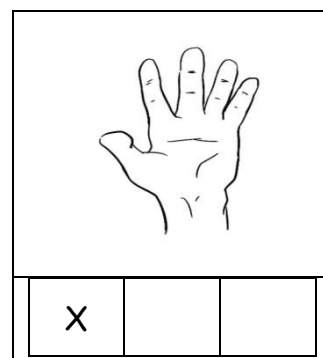
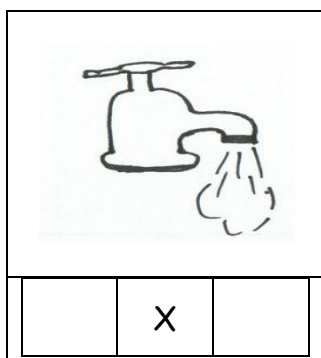
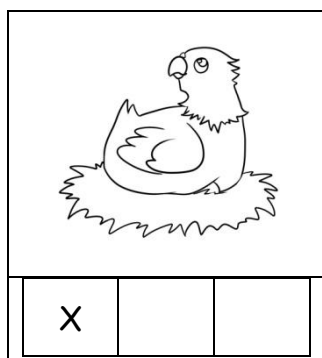
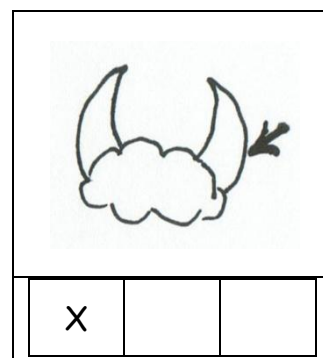
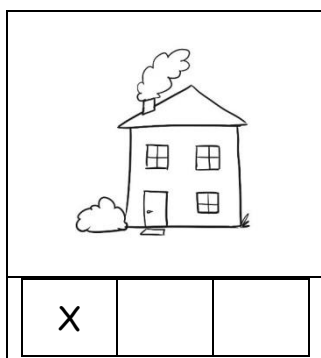
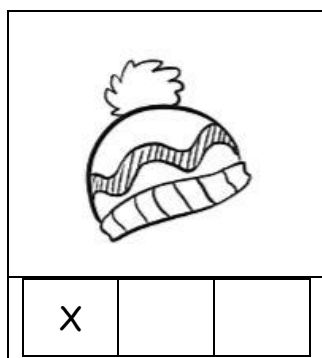
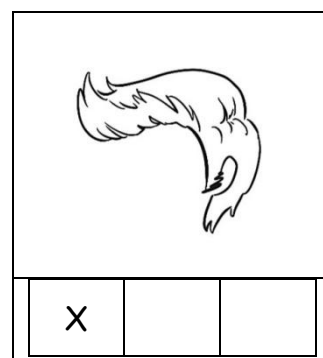
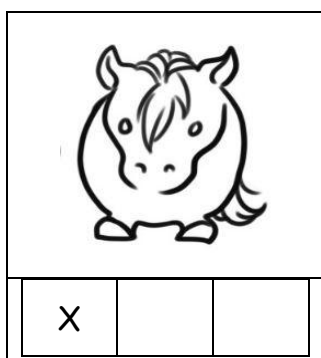
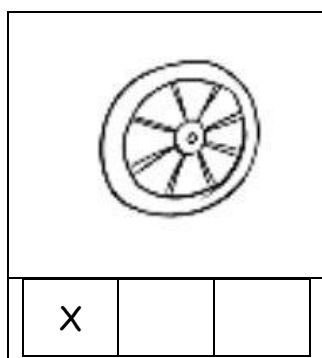

Find I lyden

Sig ordet.

Lyt til I lyden.

Sæt kryds ved I lyden i begyndelsen, i midten eller til sidst i ordet.

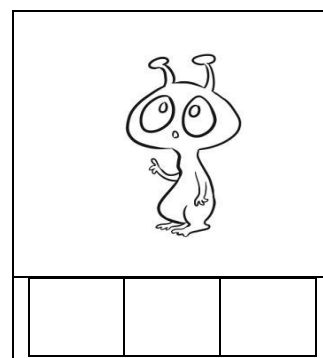
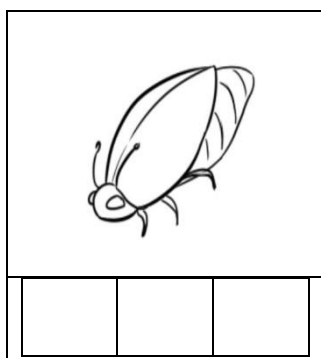
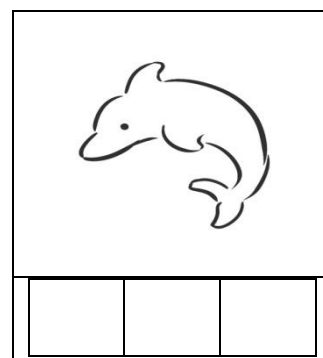
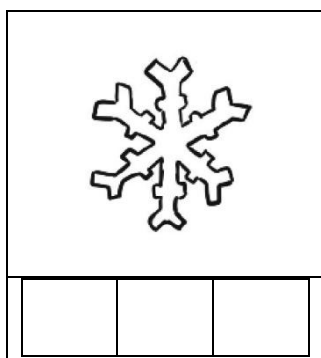
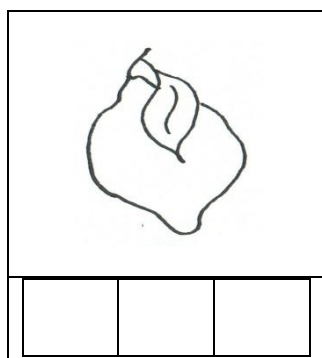
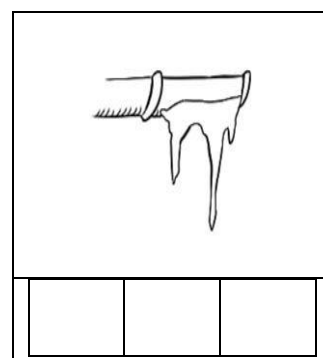
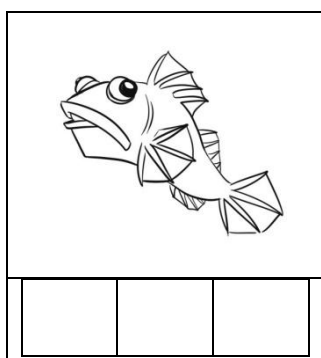
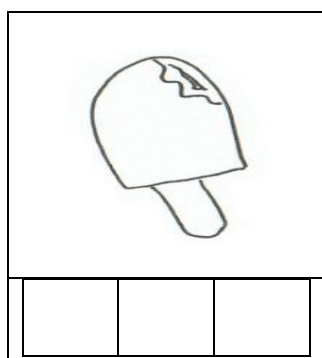

Find I lyden **LØSNING**

Sig ordet.

Lyt til **I** lyden.

Sæt kryds ved **I** lyden i begyndelsen, i midten eller til sidst i ordet.

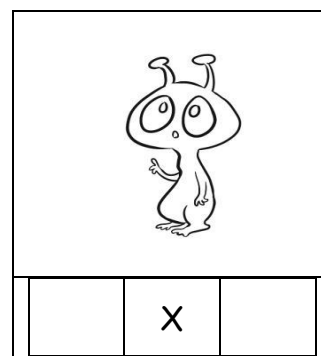
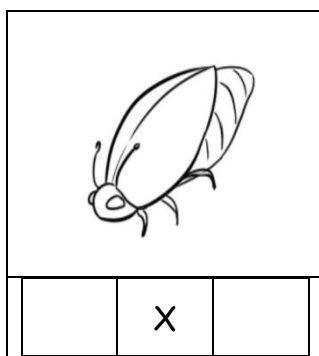
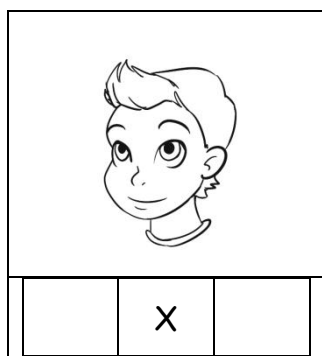
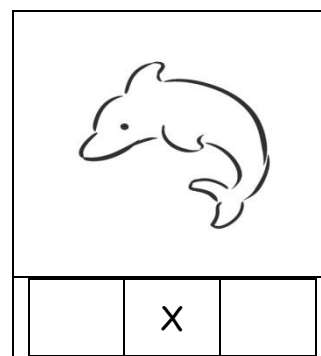
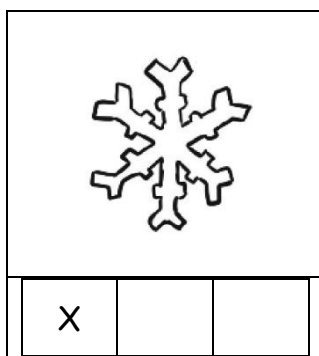
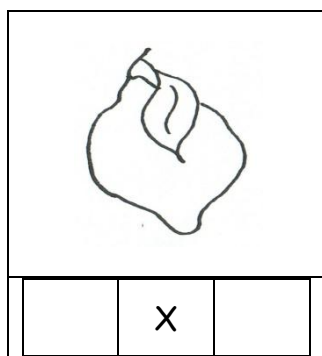
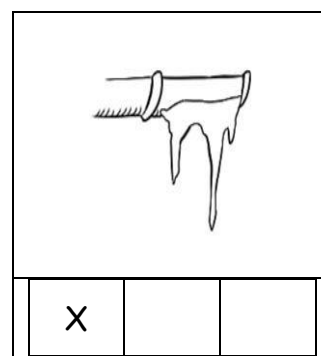
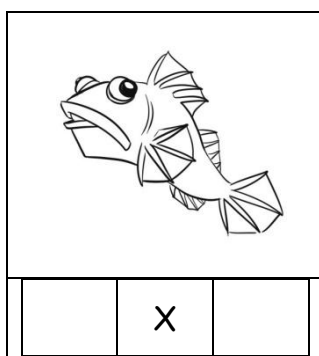
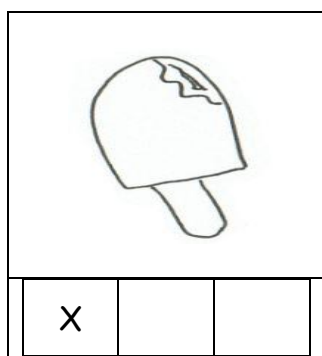

Find J lyden

Sig ordet.

Lyt til J lyden.

Sæt kryds ved J lyden i begyndelsen, i midten eller til sidst i ordet.

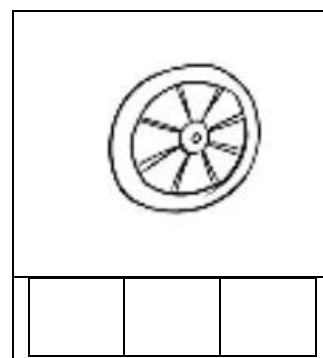
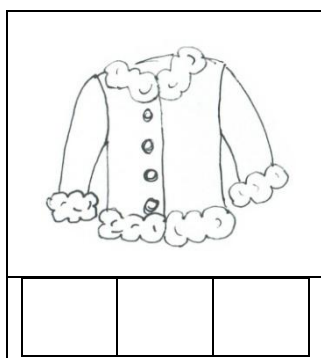
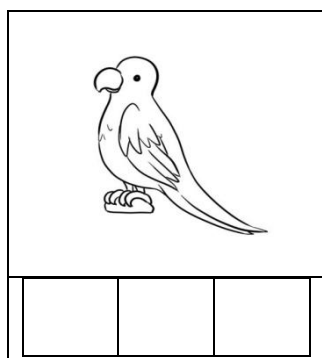
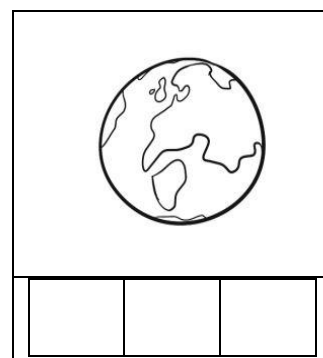
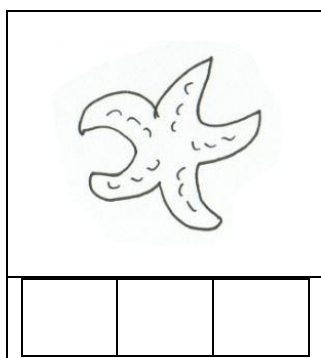
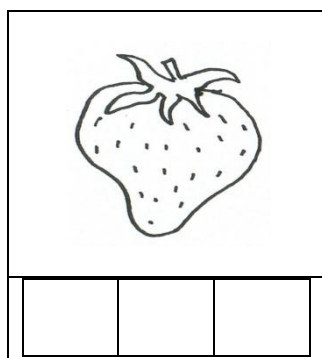
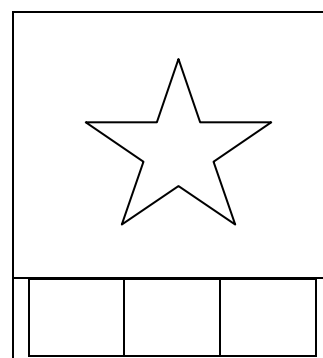
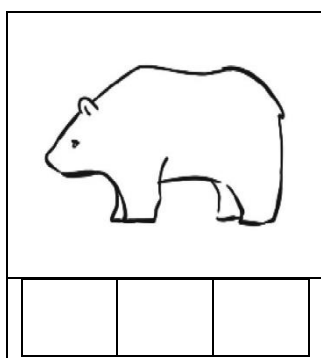
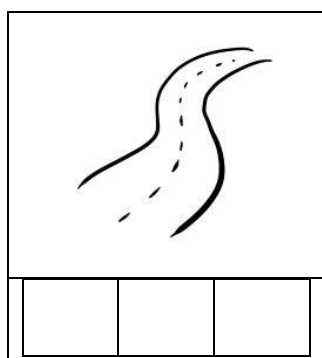

Find J lyden **LØSNING**

Sig ordet.

Lyt til J lyden.

Sæt kryds ved J lyden i begyndelsen, i midten eller til sidst i ordet.

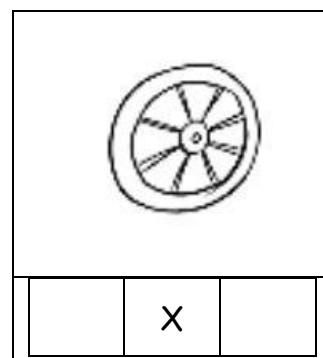
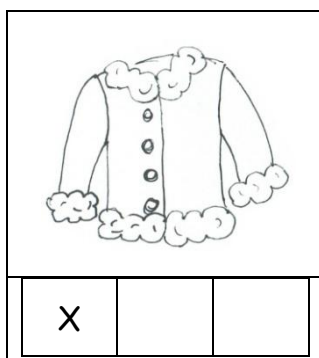
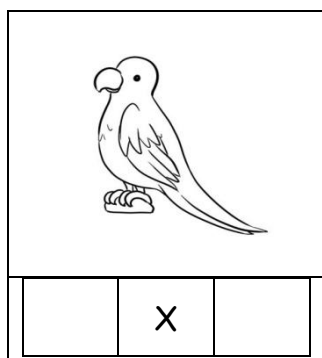
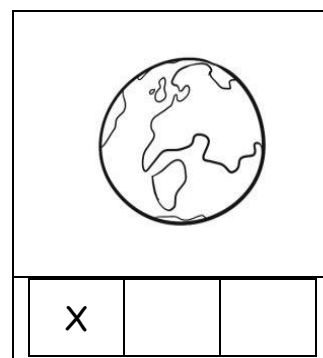
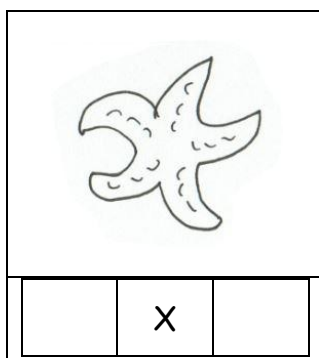
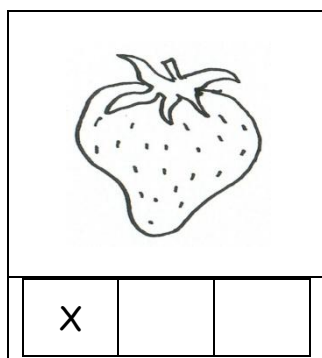
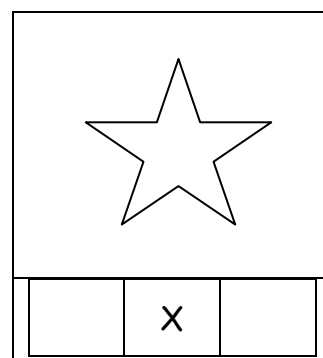
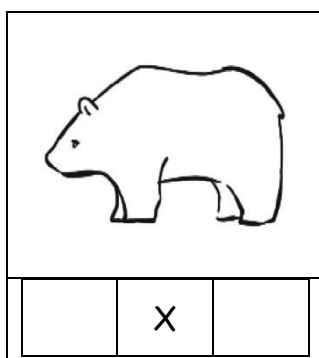
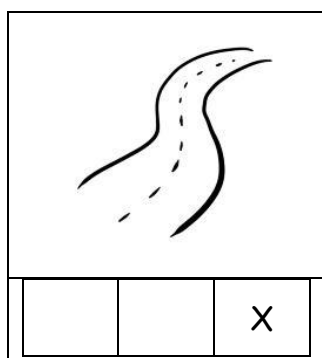

Find K lyden

Sig ordet.

Lyt til K lyden.

Sæt kryds ved K lyden i begyndelsen, i midten eller til sidst i ordet.

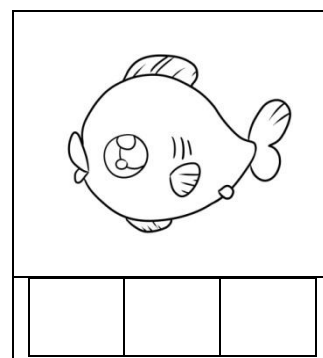
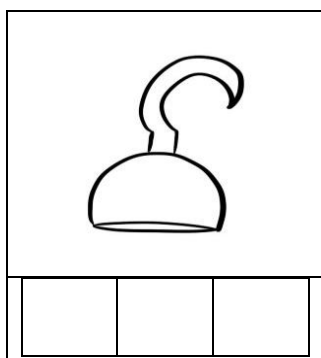
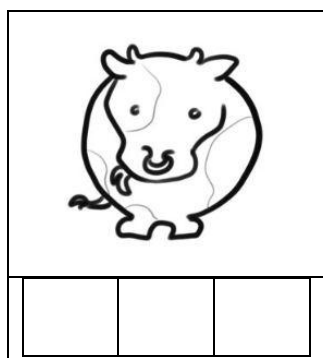
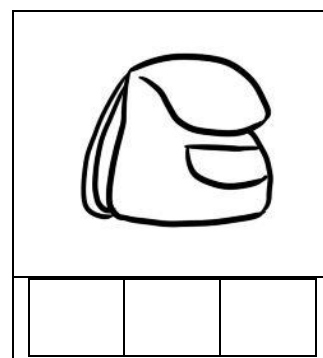
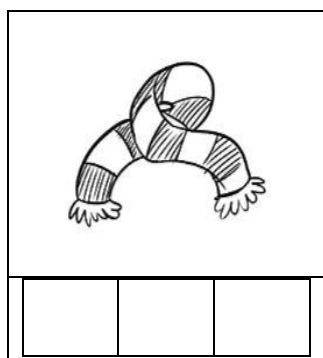
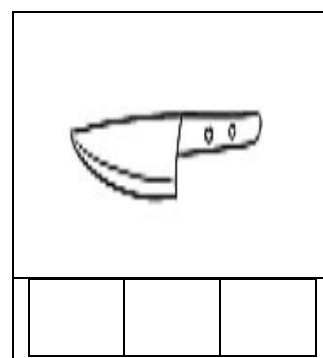
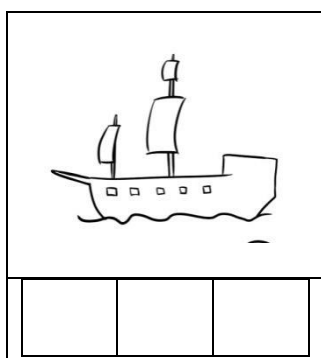
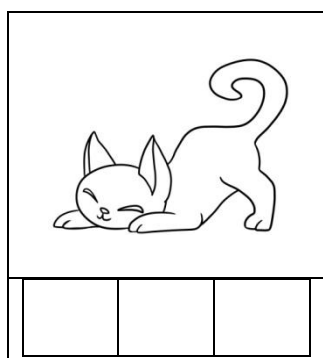

Find K lyden **LØSNING**

Sig ordet.

Lyt til K lyden.

Sæt kryds ved K lyden i begyndelsen, i midten eller til sidst i ordet.

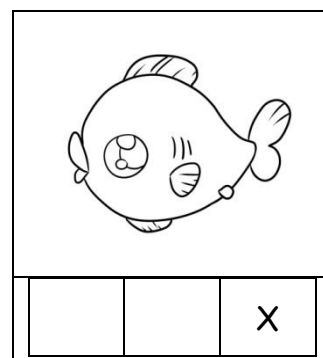
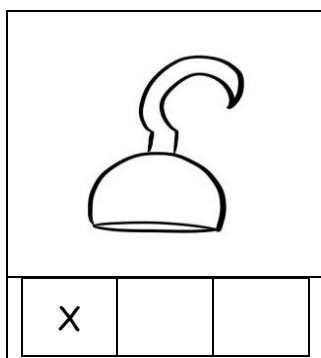
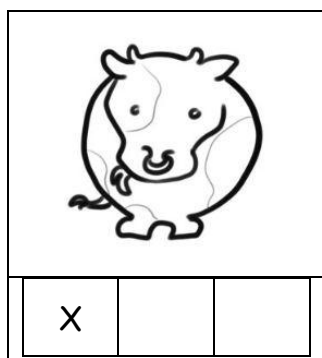
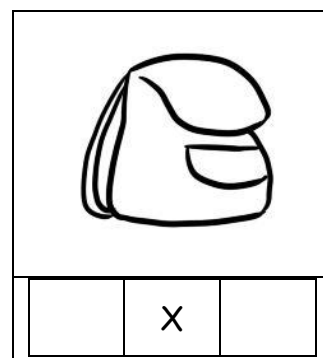
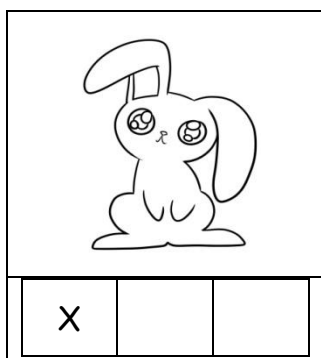
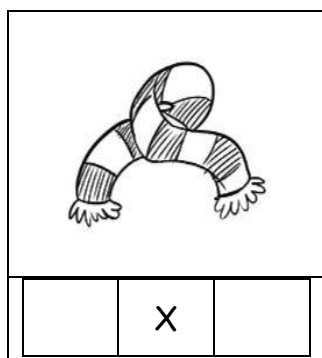
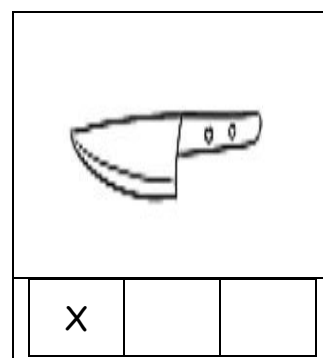
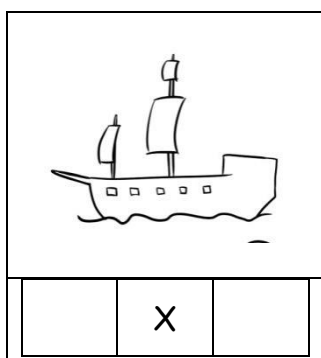
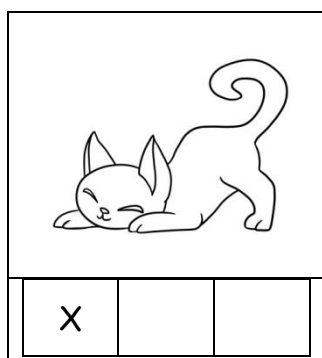

Find L lyden

Sig ordet.

Lyt til L lyden.

Sæt kryds ved K lyden i begyndelsen, i midten eller til sidst i ordet.

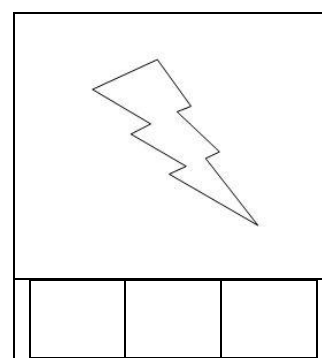
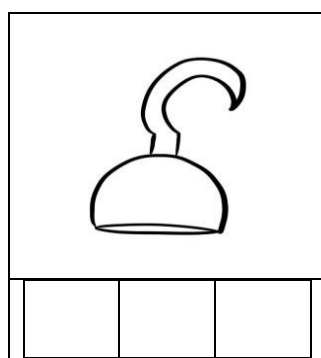
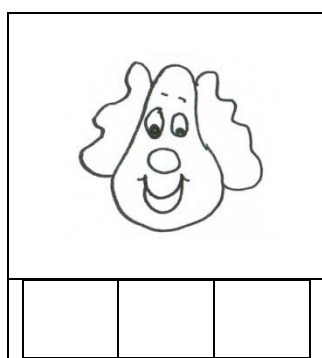
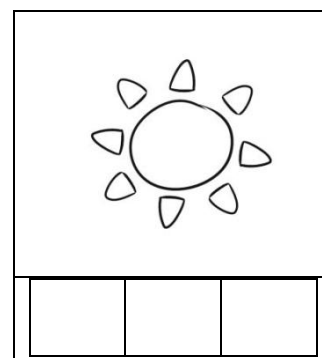
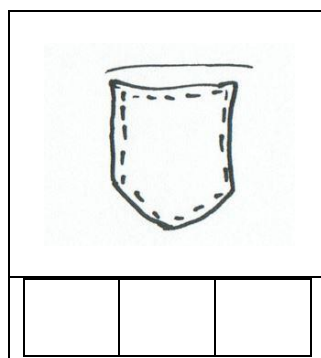
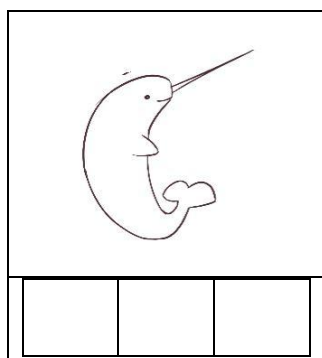
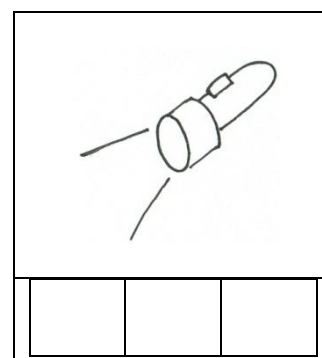
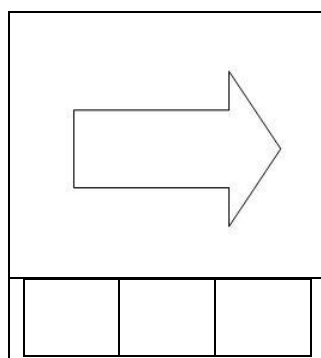
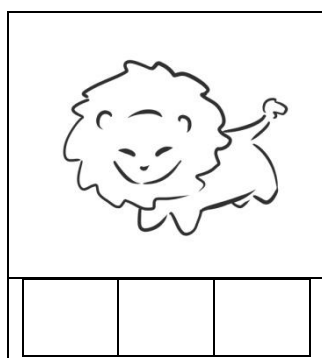

Find L lyden **LØSNING**

Sig ordet.

Lyt til L lyden.

Sæt kryds ved LLyden i begyndelsen, i midten eller til sidst i ordet.

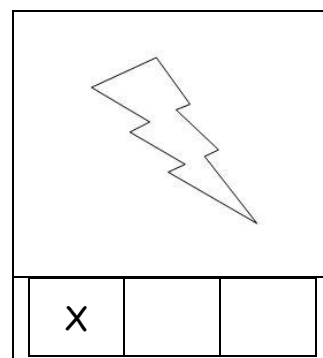
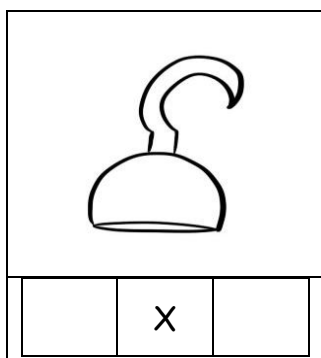
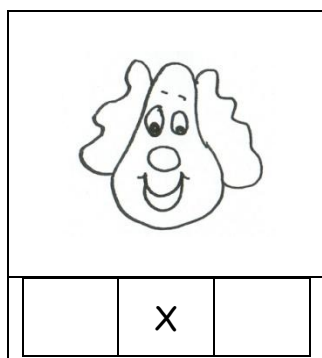
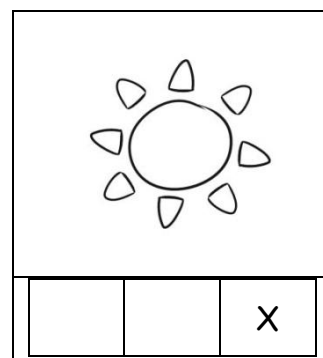
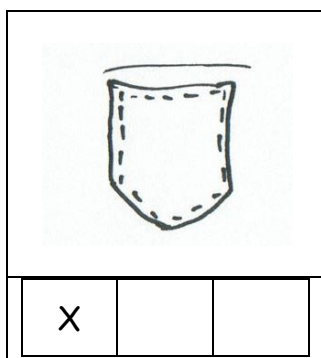
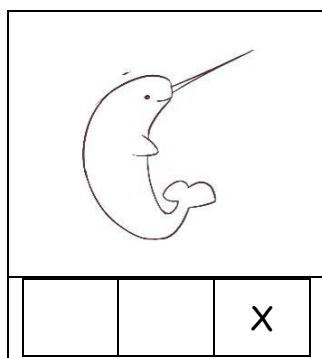
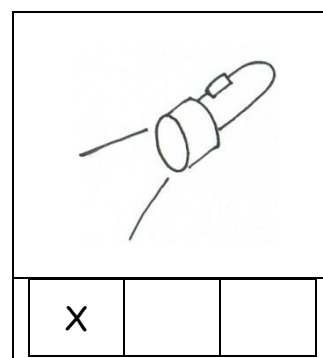
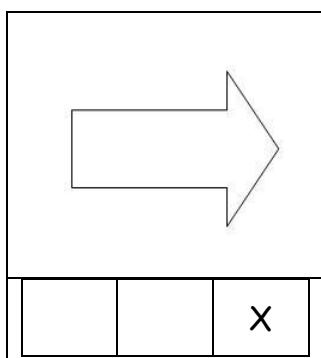
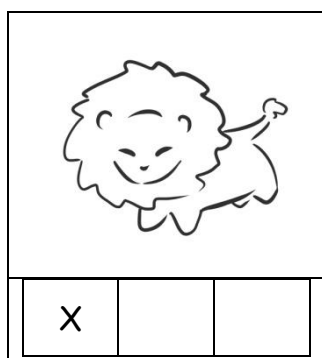

Find M lyden

Sig ordet.

Lyt til M lyden.

Sæt kryds ved M lyden i begyndelsen, i midten eller til sidst i ordet.

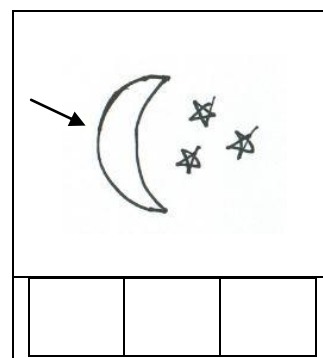
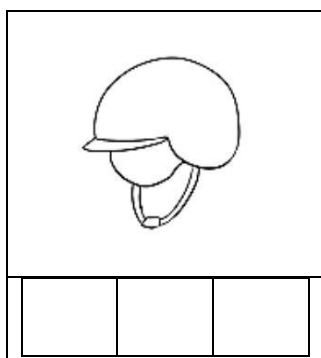
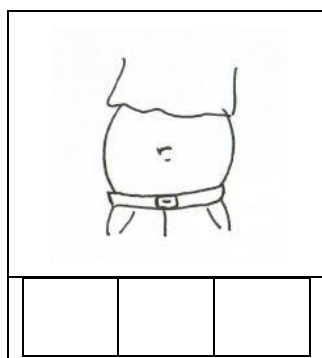
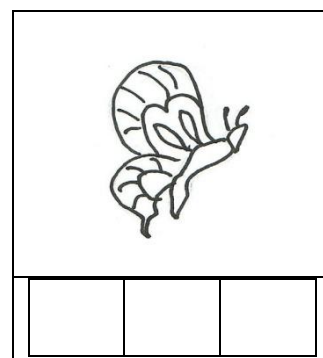
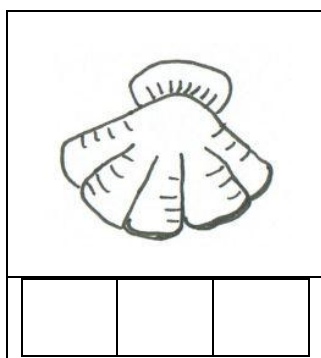
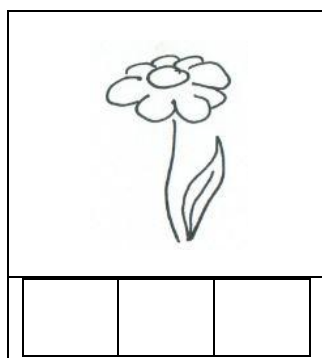
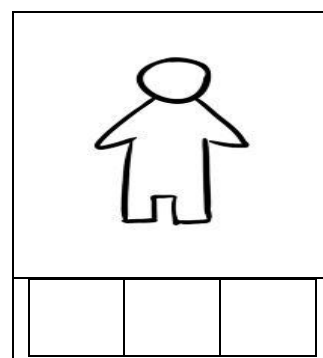
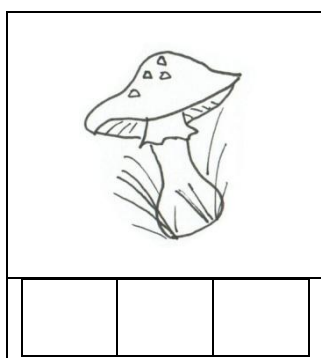
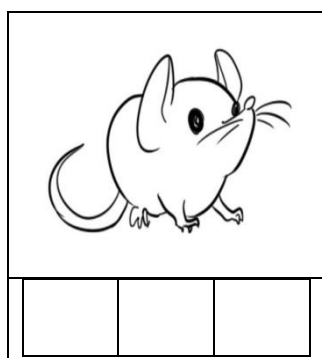

Find M lyden **LØSNING**

Sig ordet.

Lyt til M lyden.

Sæt kryds ved M lyden i begyndelsen, i midten eller til sidst i ordet.

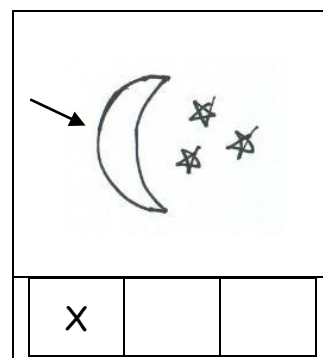
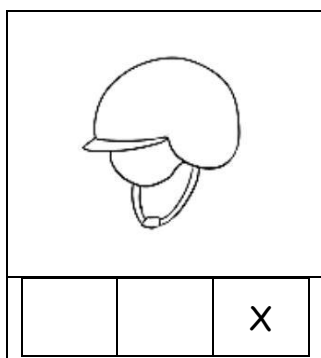
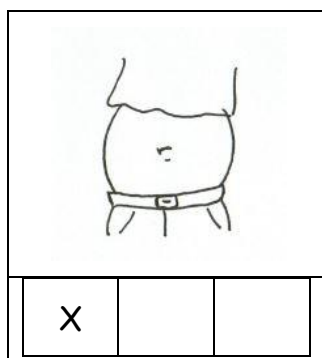
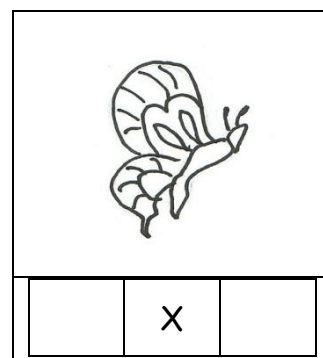
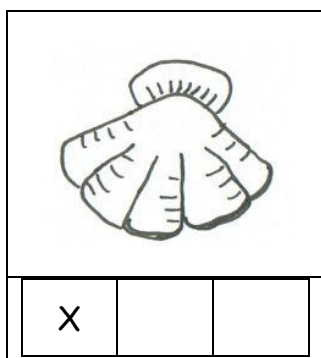
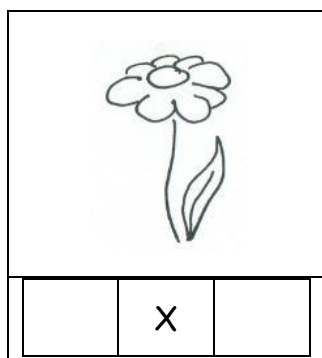
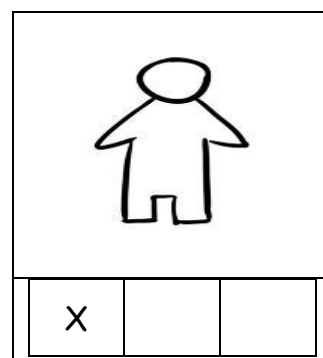
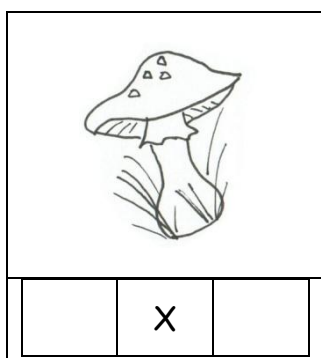
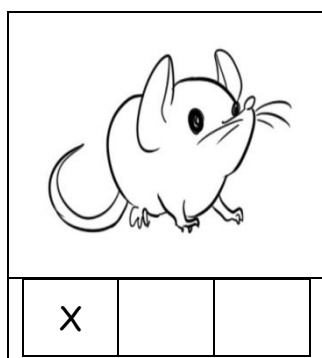

Find N lyden

Sig ordet.

Lyt til N lyden.

Sæt kryds ved N lyden i begyndelsen, i midten eller til sidst i ordet.

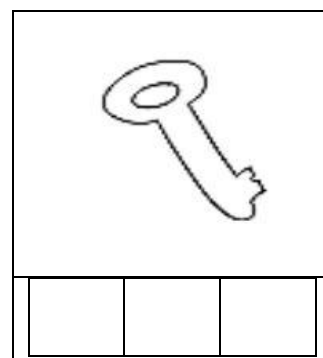
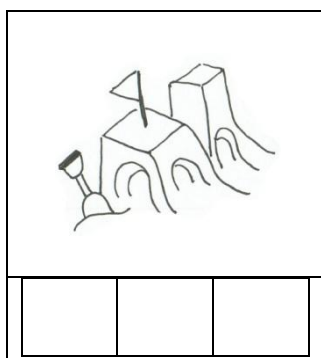
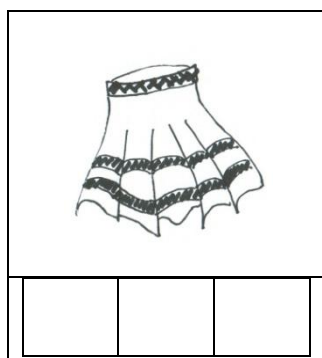
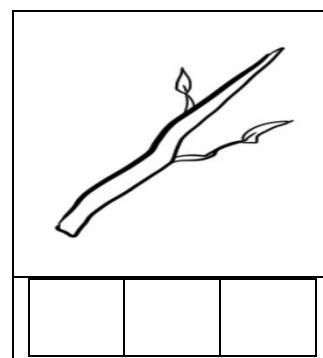
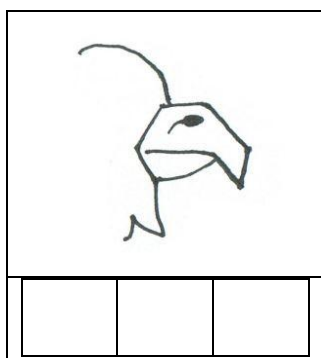
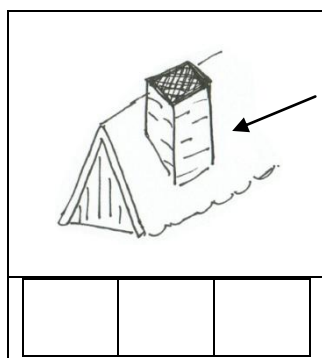
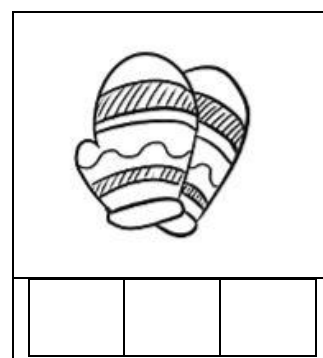
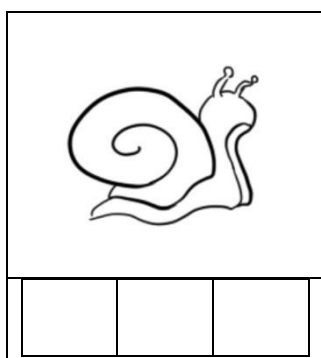
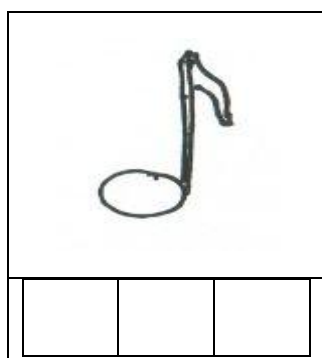

Find N lyden **LØSNING**

Sig ordet.

Lyt til N lyden.

Sæt kryds ved N lyden i begyndelsen, i midten eller til sidst i ordet.

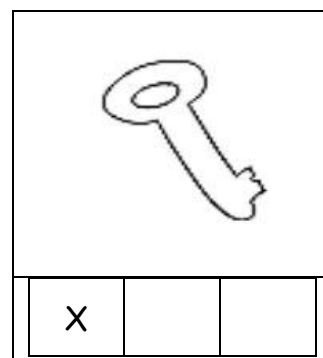
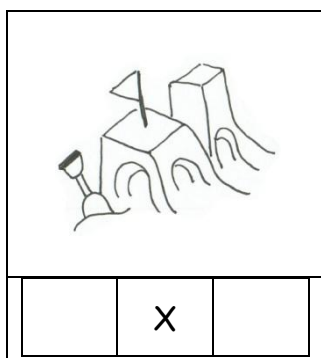
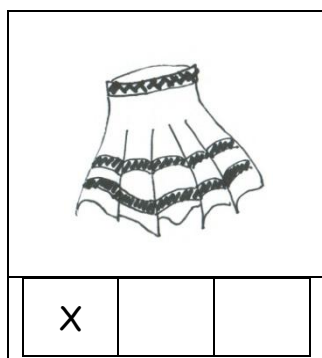
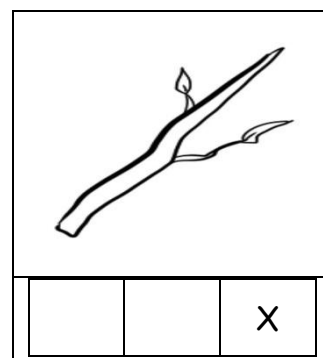
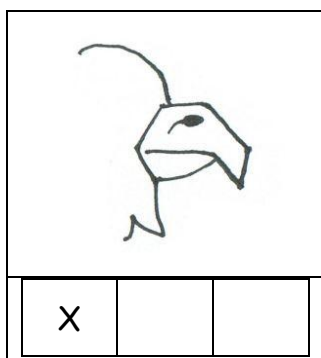
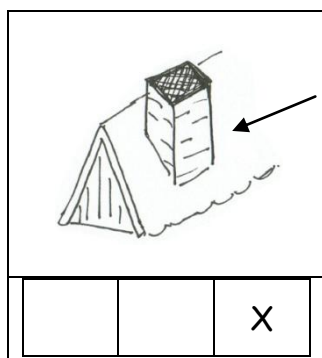
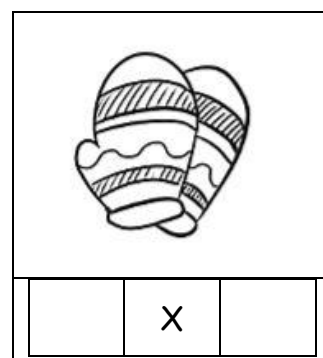
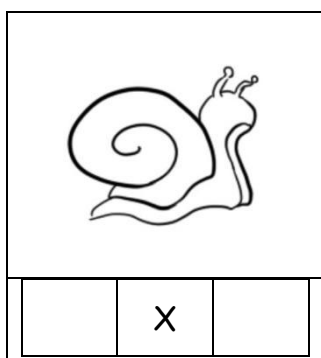
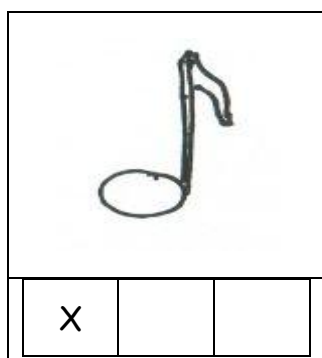

Find **O** lyden

Sig ordet.

Lyt til **O** lyden.

Sæt kryds ved **O** lyden i begyndelsen, i midten eller til sidst i ordet.

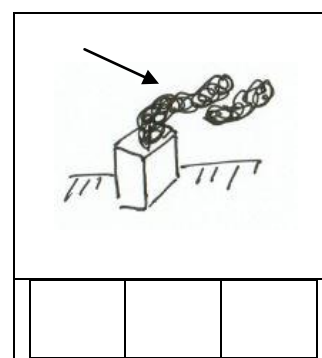
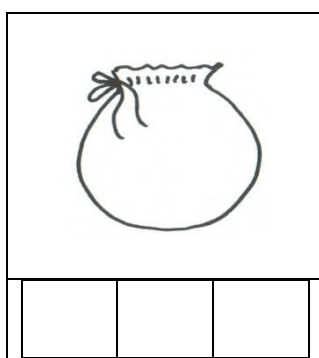
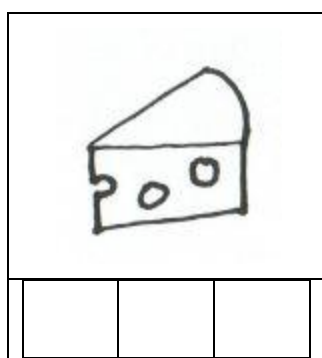
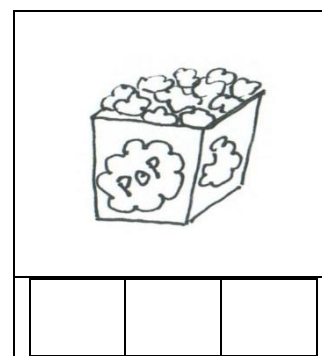
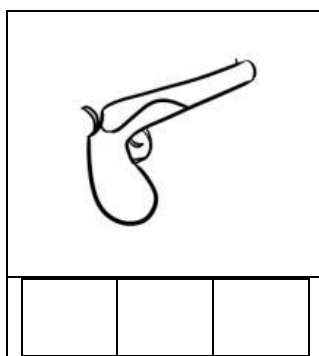
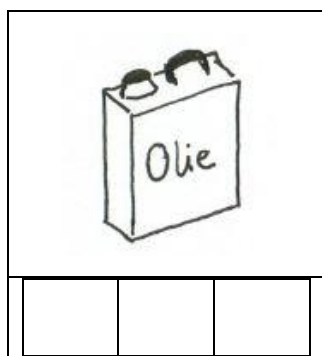
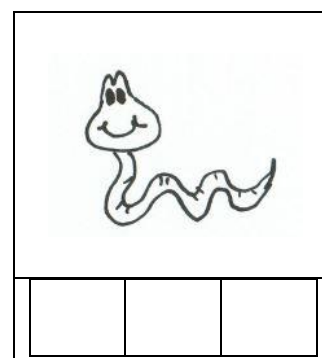
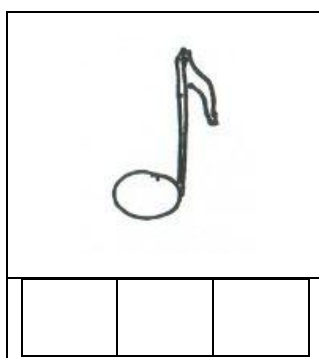
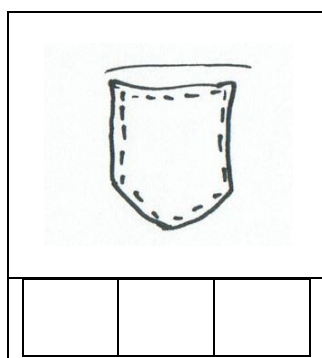

Find O lyden **LØSNING**

Sig ordet.

Lyt til O lyden.

Sæt kryds ved O lyden i begyndelsen, i midten eller til sidst i ordet.

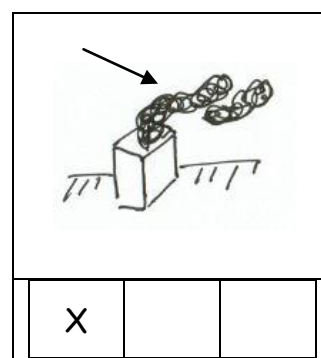
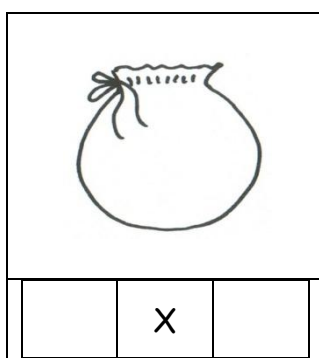
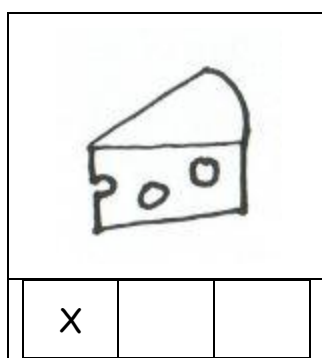
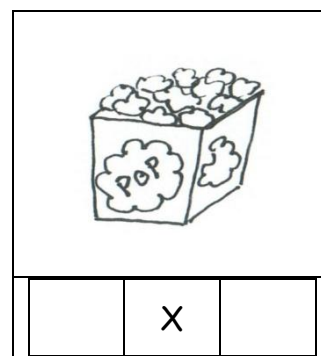
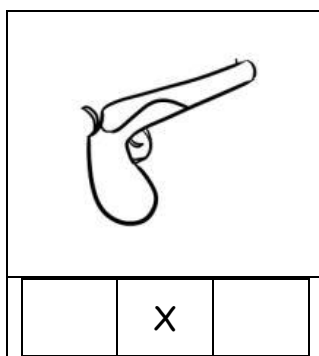
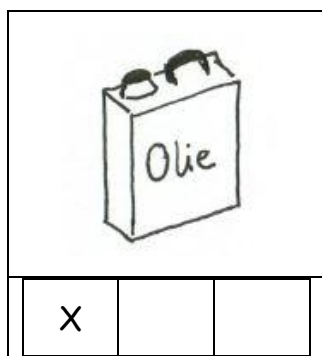
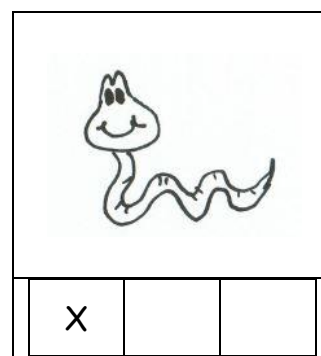
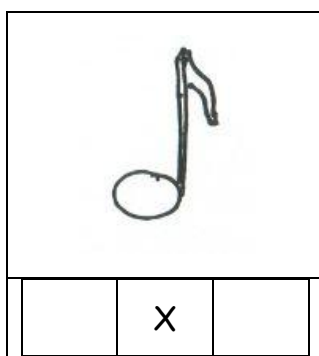
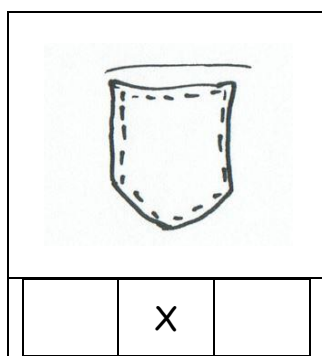

Find O lyden

Sig ordet.

Lyt til O lyden.

Sæt kryds ved O lyden i begyndelsen, i midten eller til sidst i ordet.

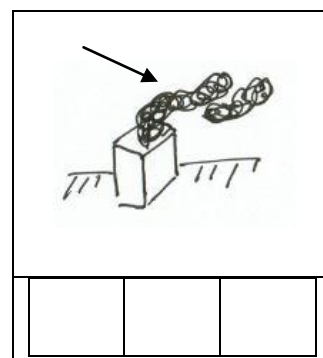
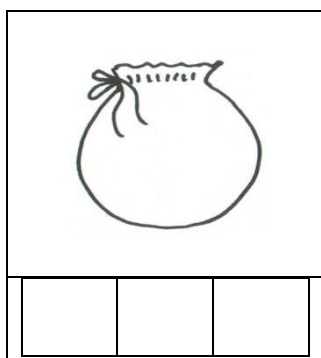
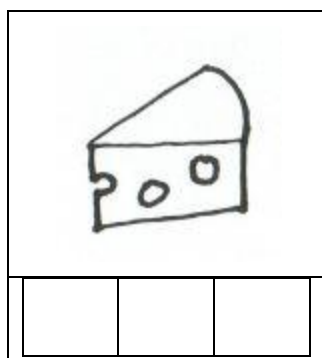
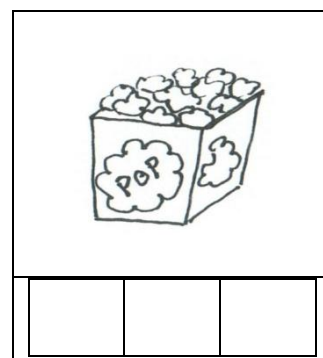
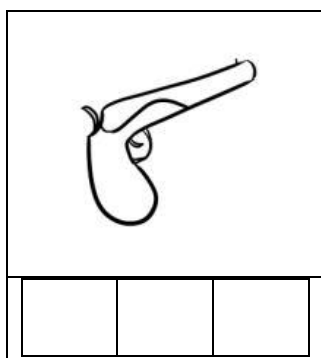
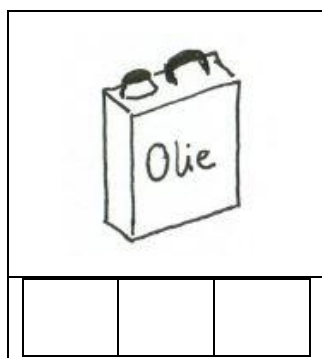
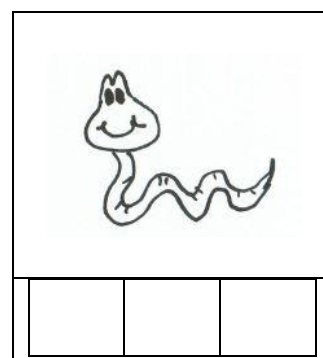
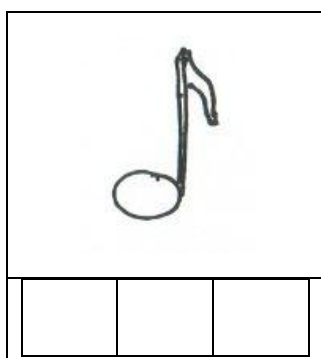
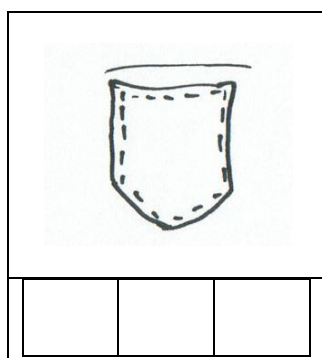

Find O lyden **LØSNING**

Sig ordet.

Lyt til O lyden.

Sæt kryds ved O lyden i begyndelsen, i midten eller til sidst i ordet.

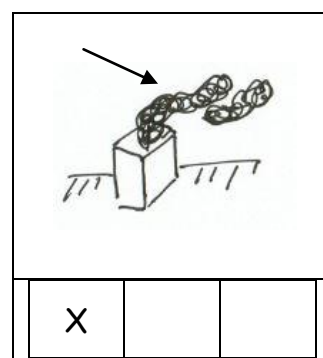
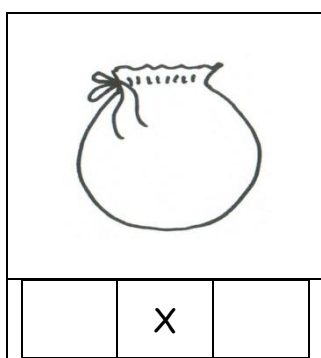
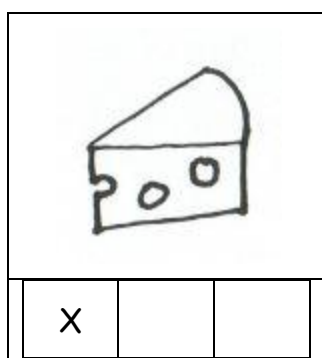
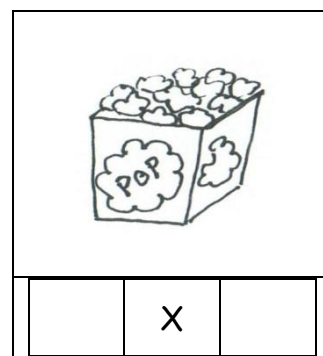
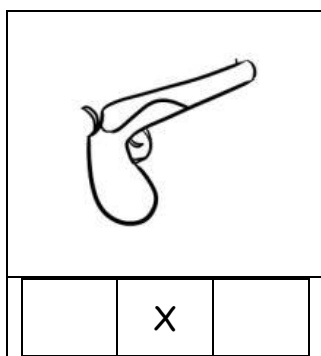
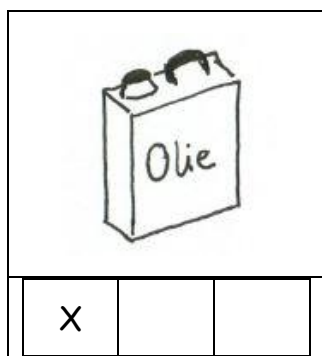
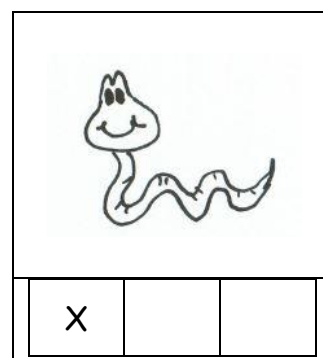
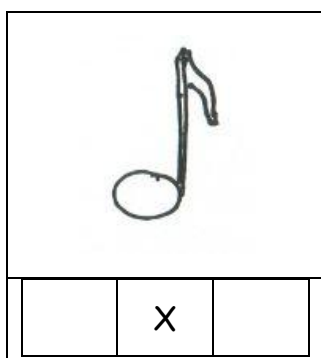
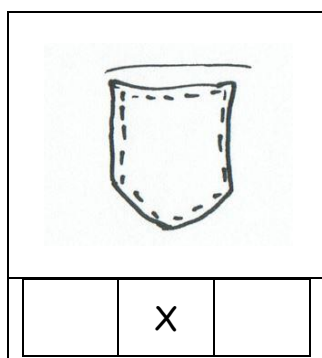

Find R lyden

Sig ordet.

Lyt til R lyden.

Sæt kryds ved R lyden i begyndelsen, i midten eller til sidst i ordet.

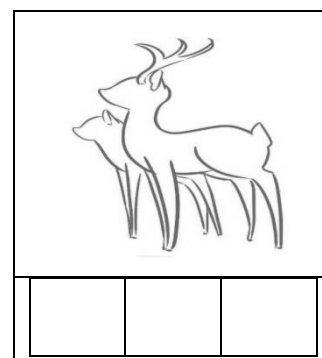
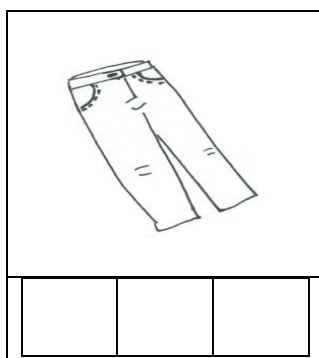
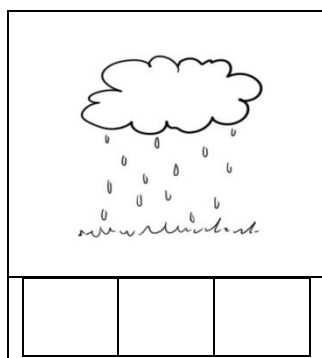
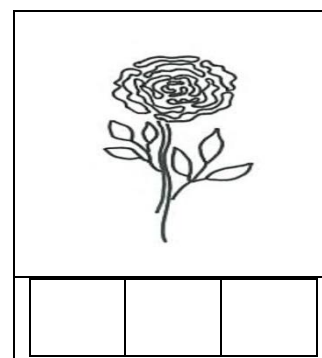
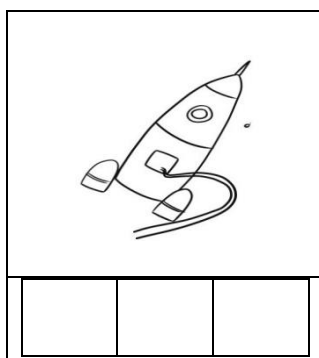
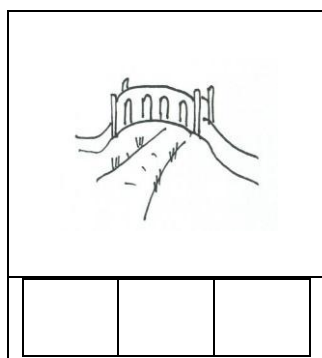
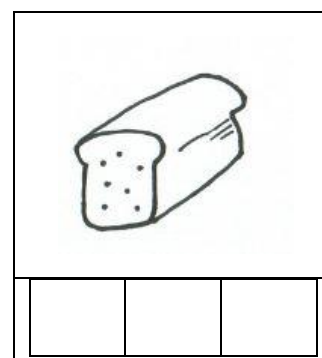
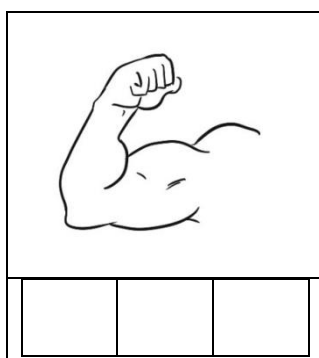
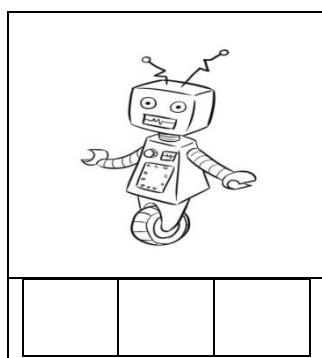

Find R lyden **LØSNING**

Sig ordet.

Lyt til R lyden.

Sæt kryds ved R lyden i begyndelsen, i midten eller til sidst i ordet.

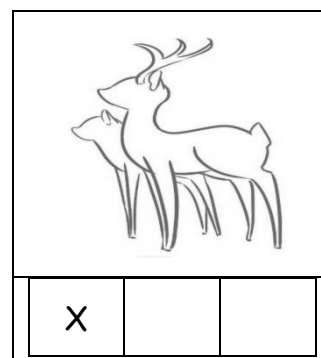
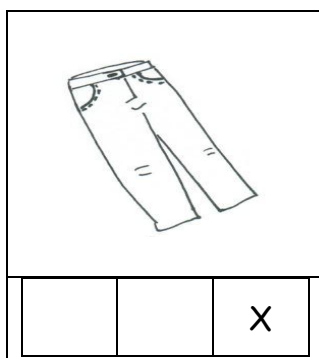
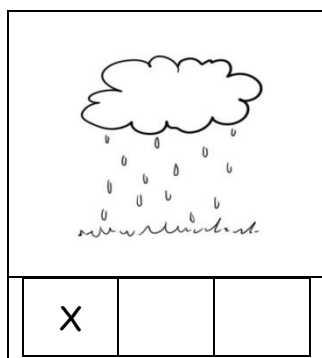
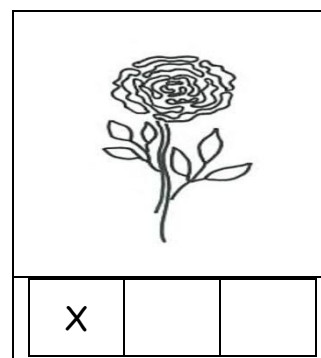
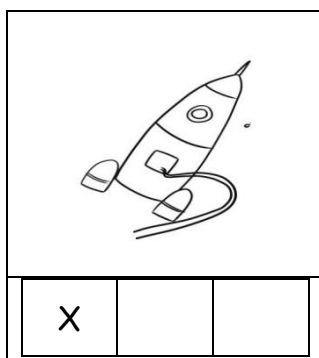
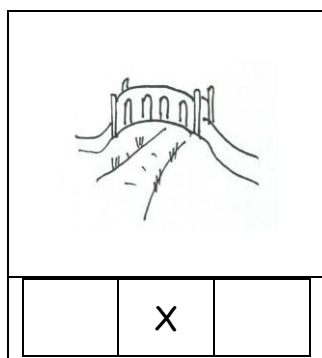
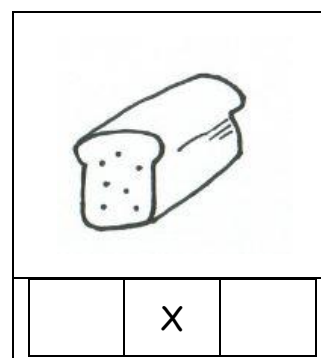
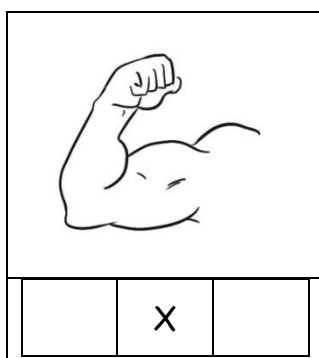
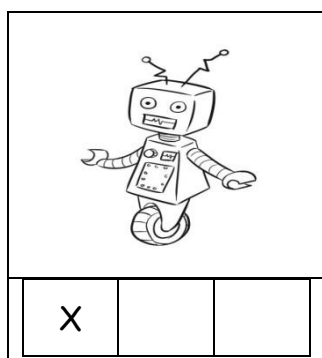

Find S lyden

Sig ordet.

Lyt til S lyden.

Sæt kryds ved S lyden i begyndelsen, i midten eller til sidst i ordet.

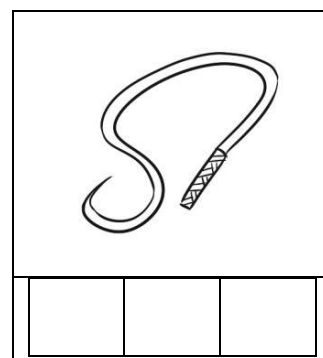
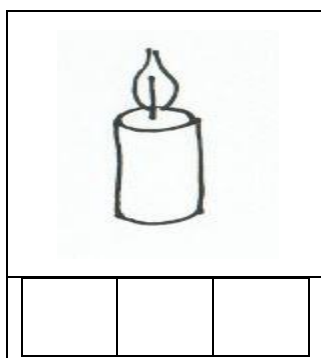
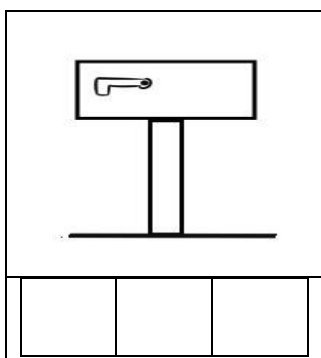
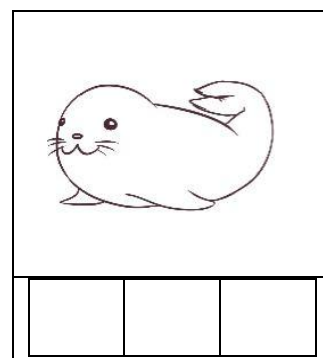
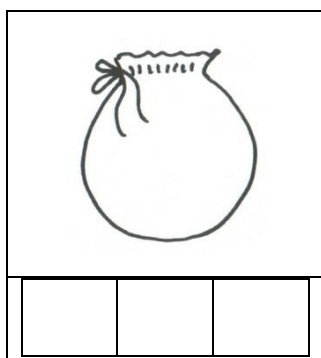
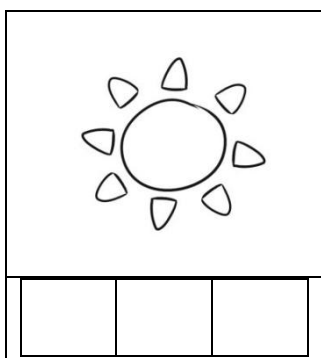
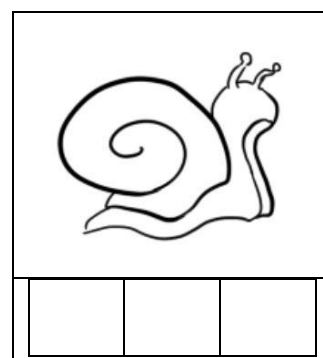
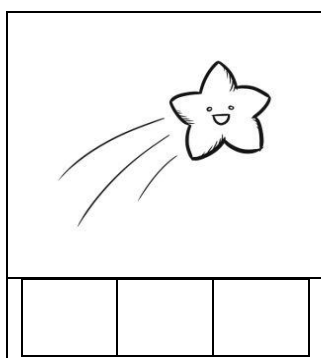
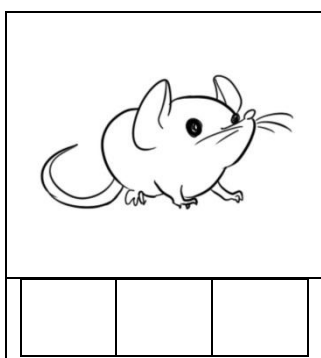

Find S lyden **LØSNING**

Sig ordet.

Lyt til S lyden.

Sæt kryds ved S lyden i begyndelsen, i midten eller til sidst i ordet.

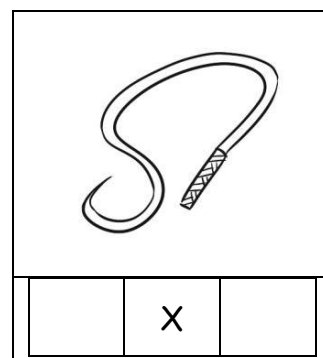
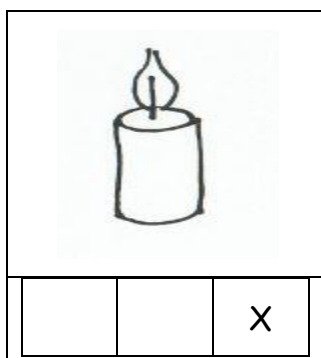
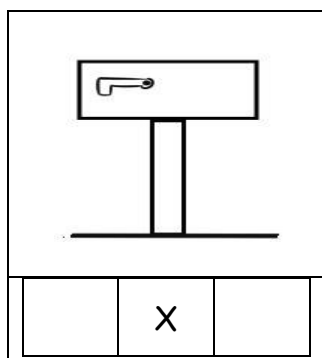
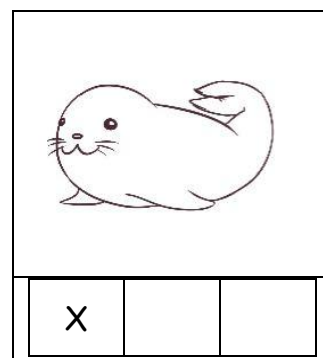
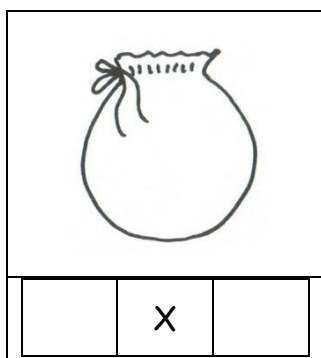
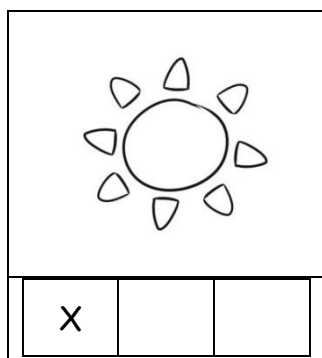
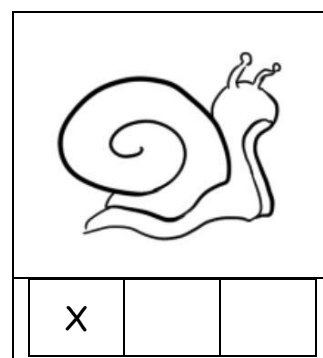
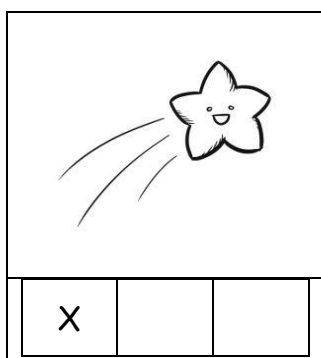
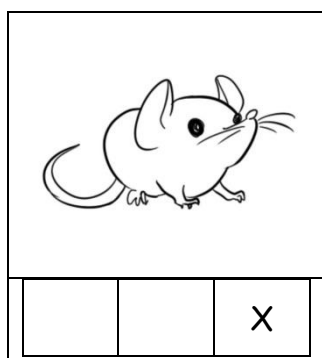

Find T lyden

Sig ordet.

Lyt til T lyden.

Sæt kryds ved T lyden i begyndelsen, i midten eller til sidst i ordet.

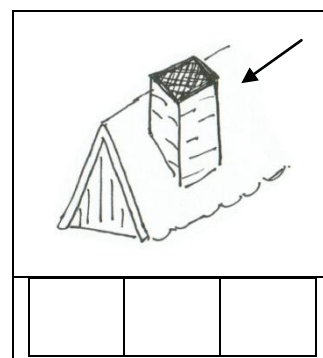
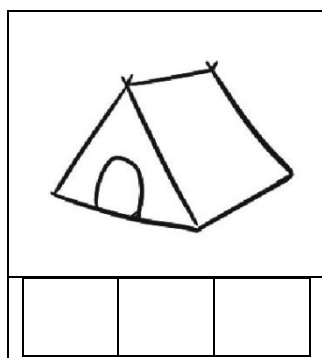
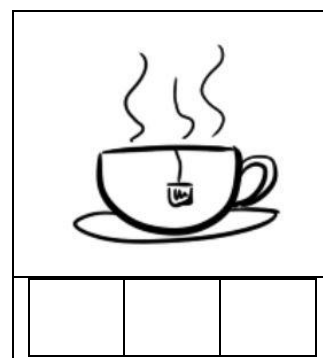
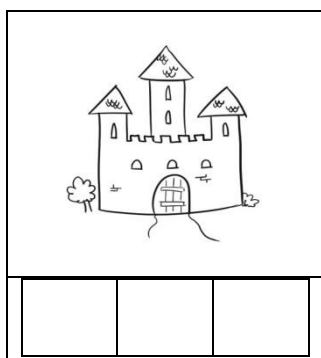
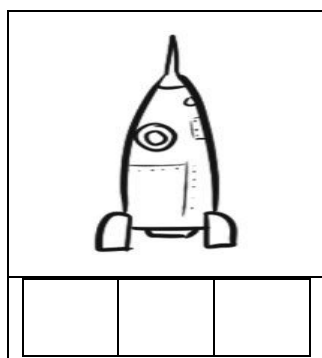
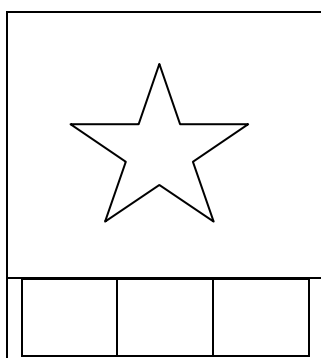
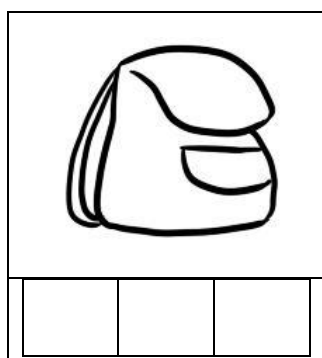

Find T lyden **LØSNING**

Sig ordet.

Lyt til T lyden.

Sæt kryds ved T lyden i begyndelsen, i midten eller til sidst i ordet.

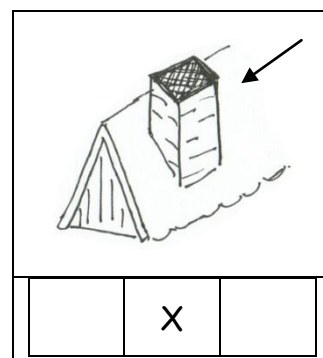
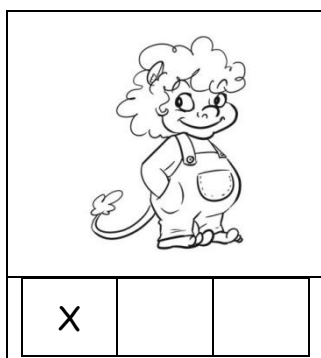
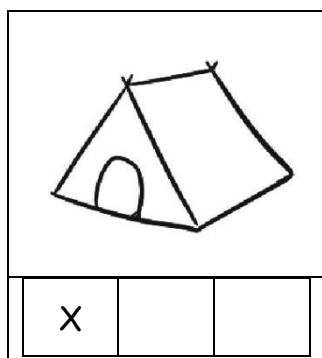
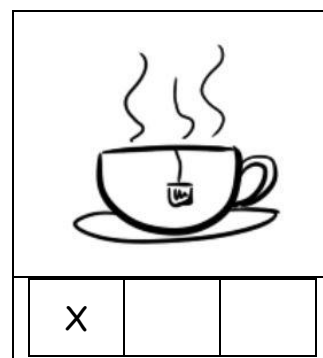
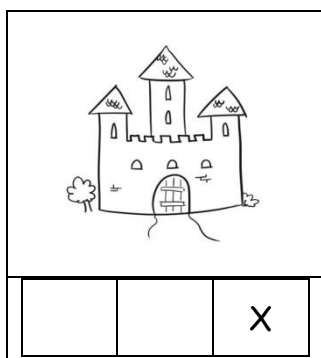
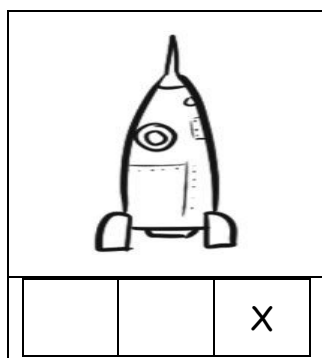
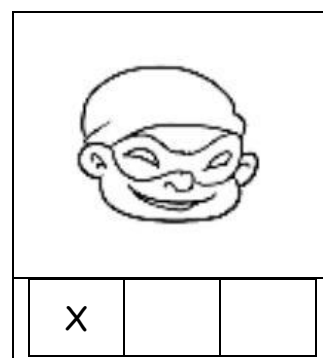
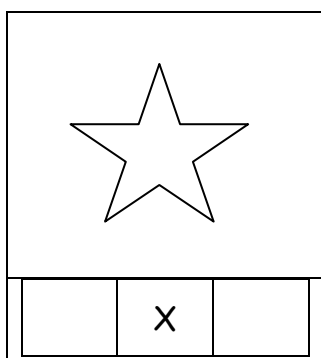
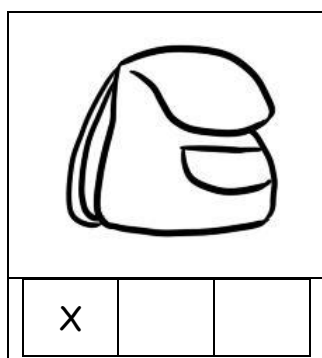

Find U lyden

Sig ordet.

Lyt til U lyden.

Sæt kryds ved U lyden i begyndelsen, i midten eller til sidst i ordet.

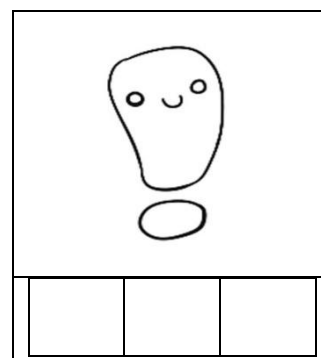
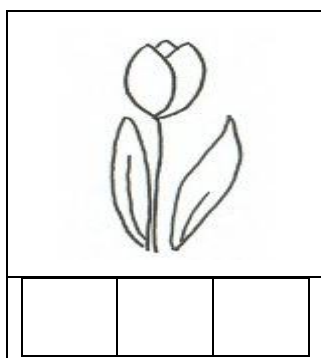
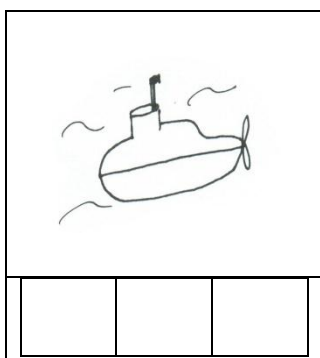
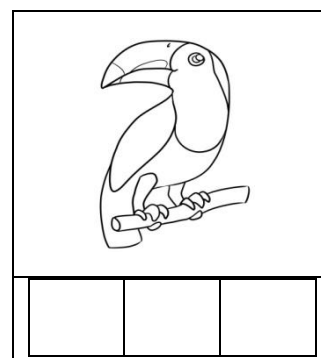
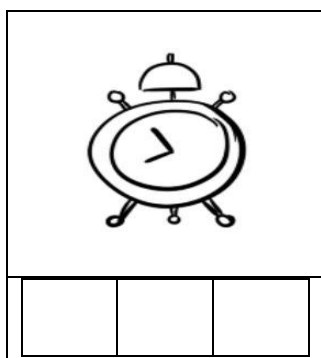
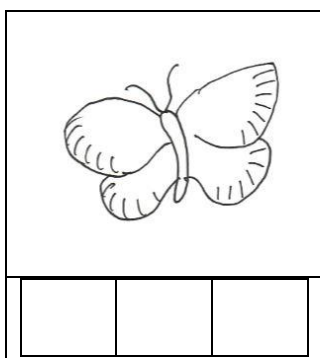
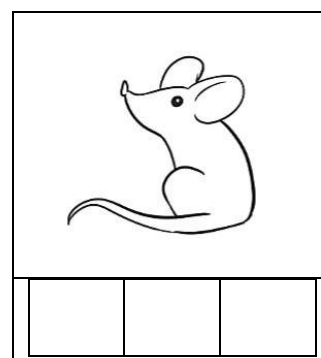
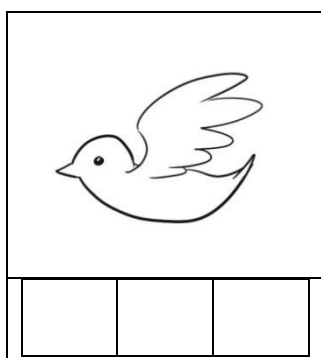
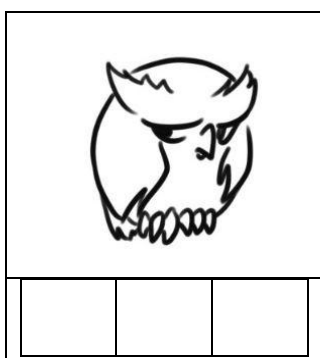

Find U lyden **LØSNING**

Sig ordet.

Lyt til U lyden.

Sæt kryds ved U lyden i begyndelsen, i midten eller til sidst i ordet.

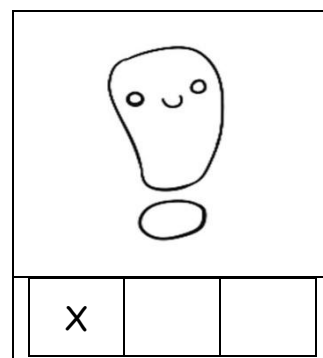
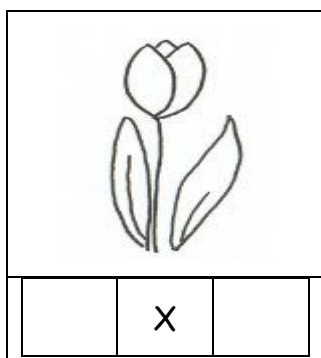
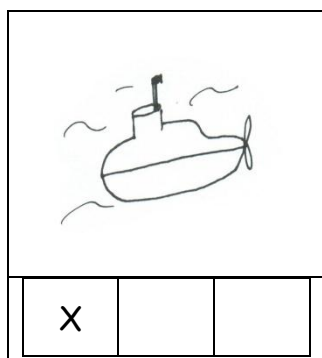
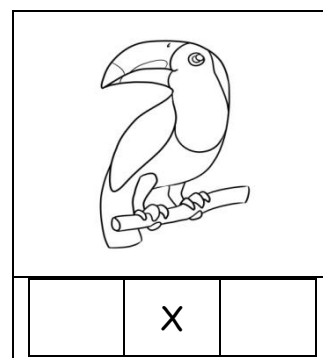
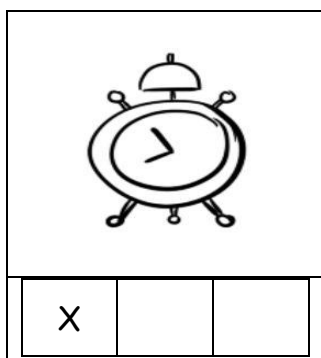
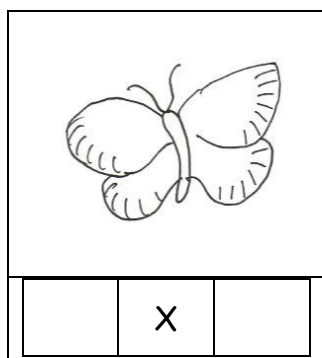
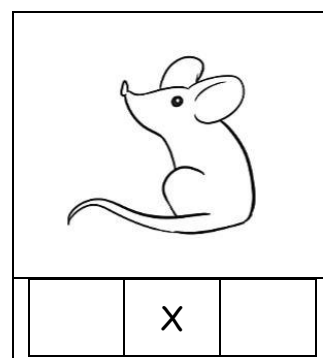
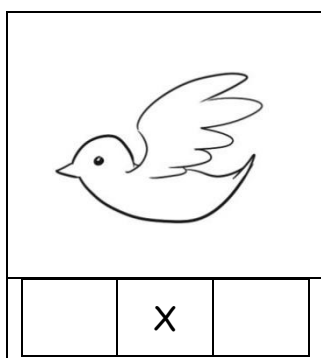
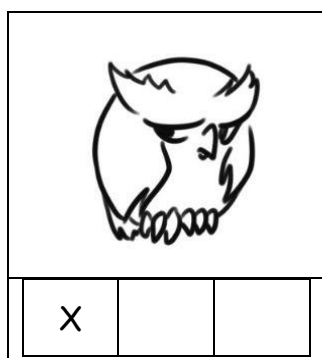

Find V lyden

Sig ordet.

Lyt til V lyden.

Sæt kryds ved V lyden i begyndelsen, i midten eller til sidst i ordet.

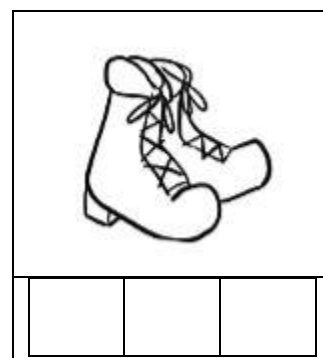
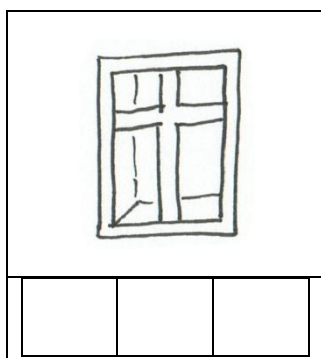
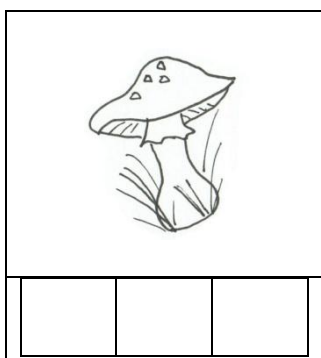
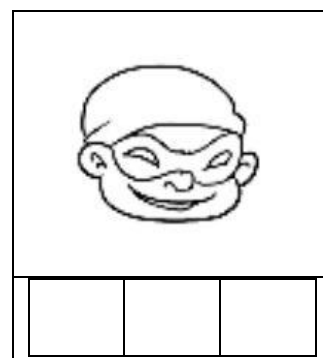
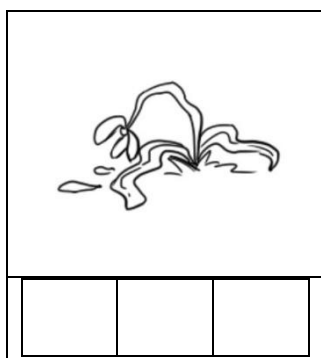
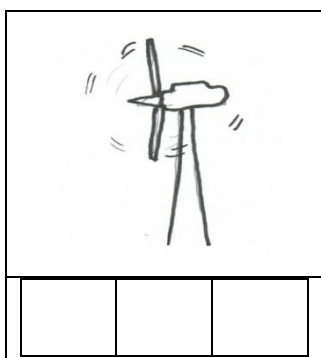
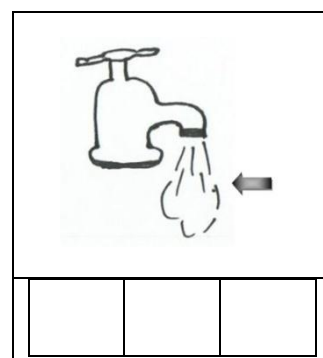
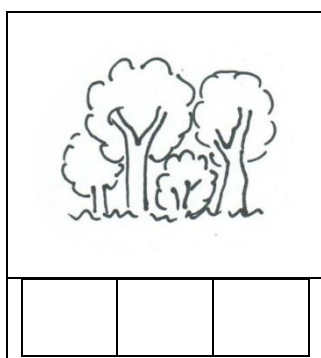
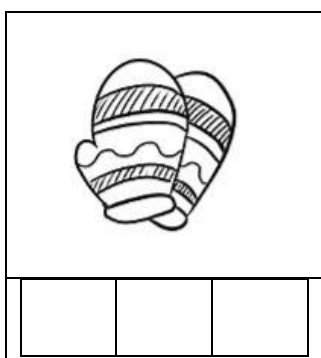

Find V lyden **LØSNING**

Sig ordet.

Lyt til V lyden.

Sæt kryds ved V lyden i begyndelsen, i midten eller til sidst i ordet.

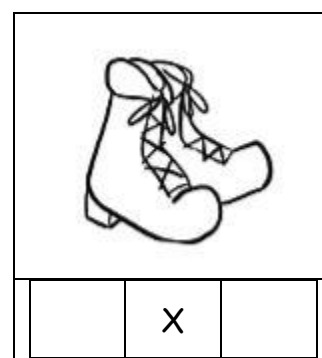
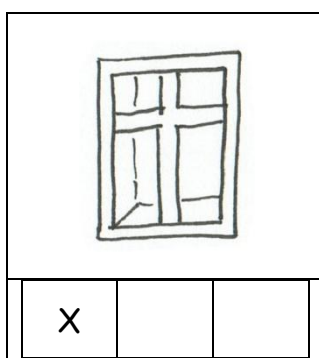
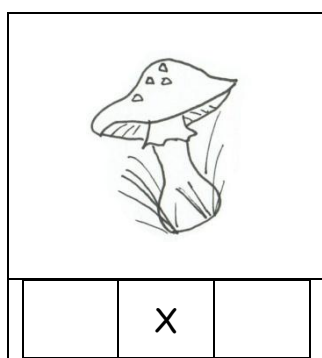
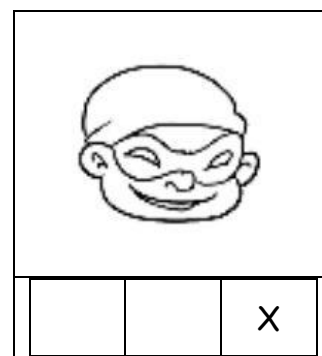
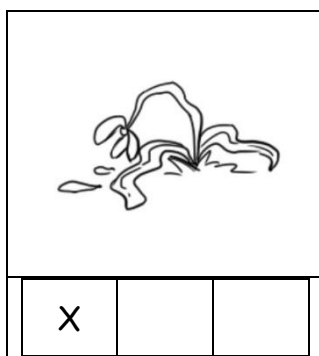
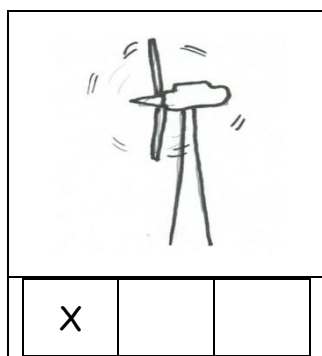
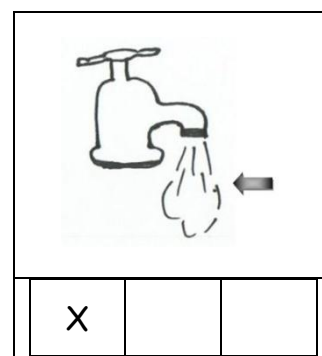
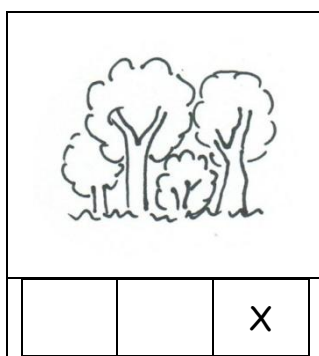
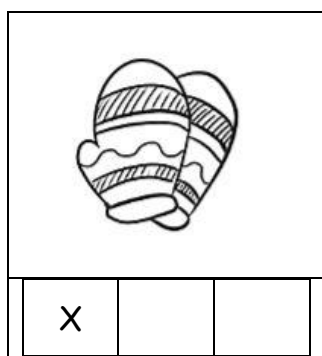

Find Y lyden

Sig ordet.

Lyt til Y lyden.

Sæt kryds ved Y lyden i begyndelsen, i midten eller til sidst i ordet.

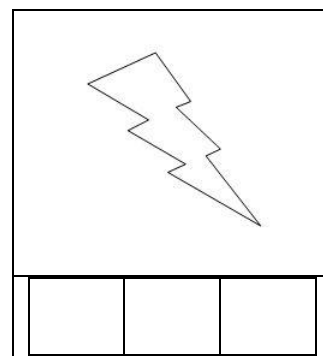
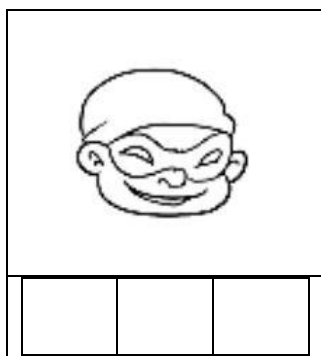
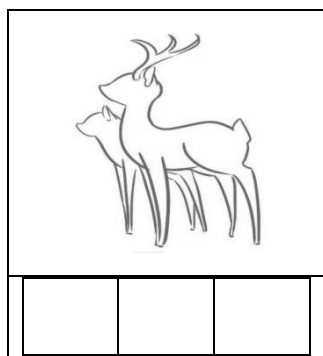
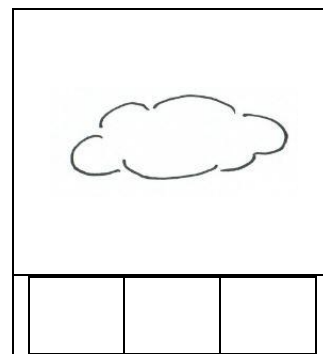
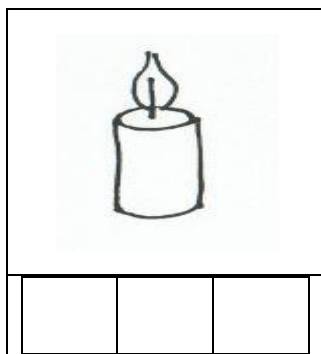
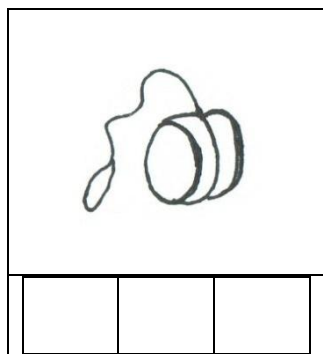
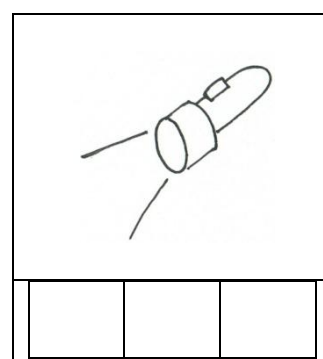
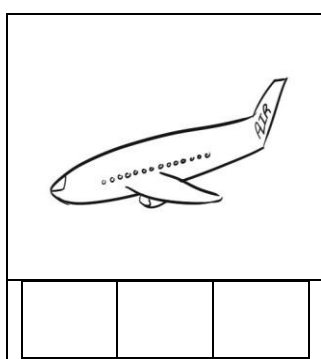
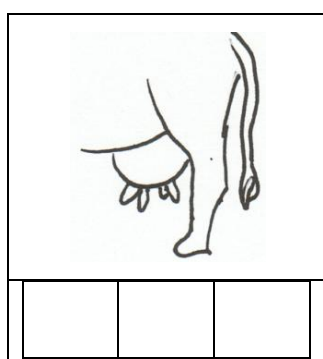



Find Y lyden **LØSNING**

Sig ordet.

Lyt til Y lyden.

Sæt kryds ved Y lyden i begyndelsen, i midten eller til sidst i ordet.

		
x		

		
	x	

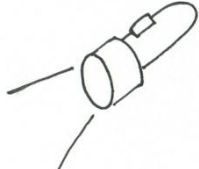
		
	x	

		
x	x	

		
	x	

		
		x

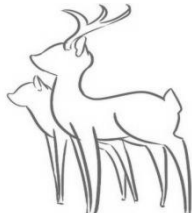
		
	x	

		
	x	

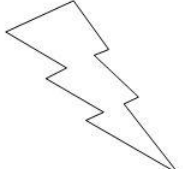
		
	x	

Find Æ lyden

Sig ordet.

Lyt til Æ lyden.

Sæt kryds ved Æ lyden i begyndelsen, i midten eller til sidst i ordet.

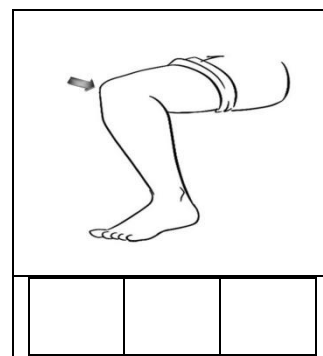
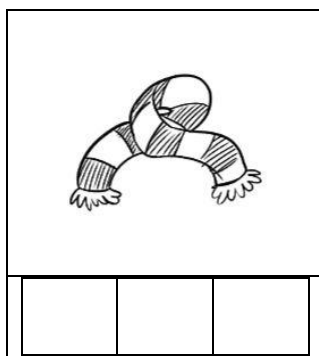
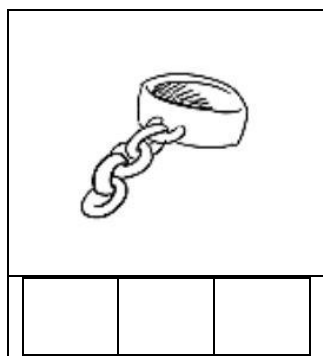
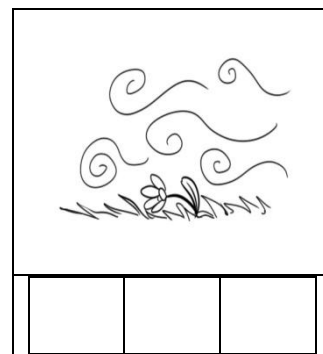
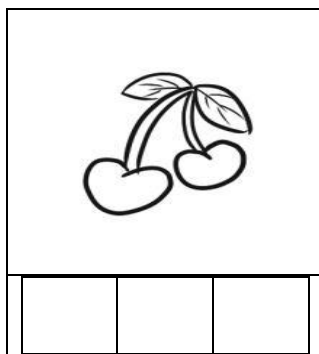
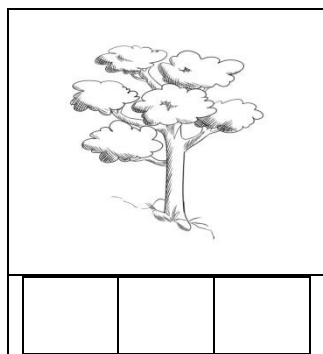
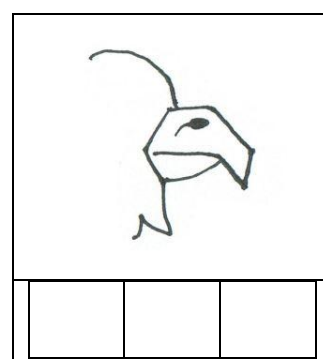
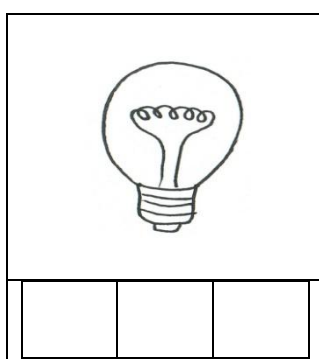
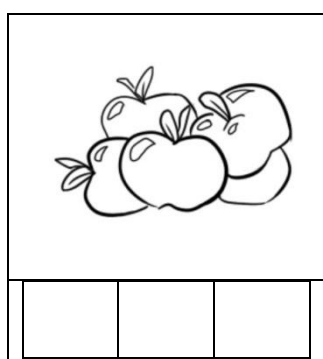

Find **Æ** lyden **LØSNING**

Sig ordet.

Lyt til **Æ** lyden.

Sæt kryds ved **Æ** lyden i begyndelsen, i midten eller til sidst i ordet.

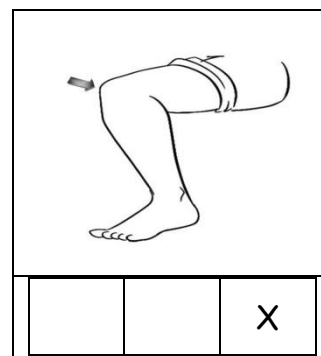
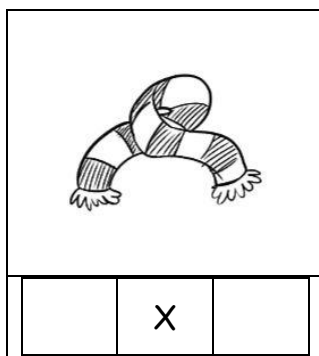
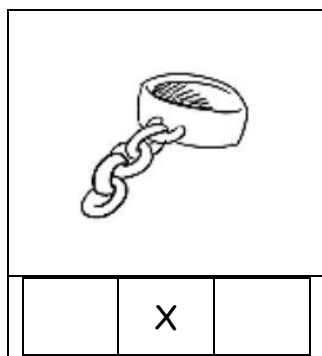
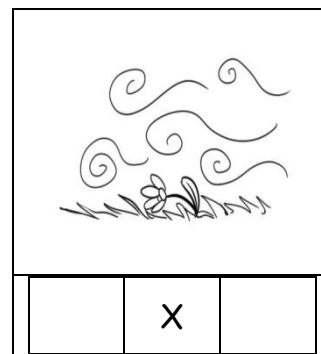
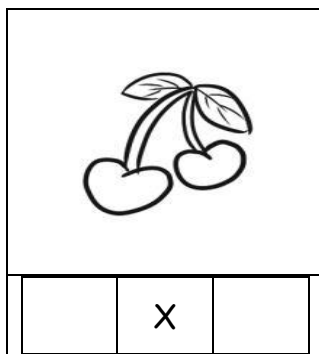
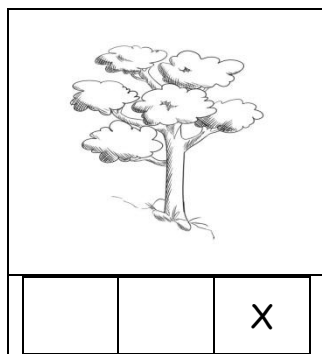
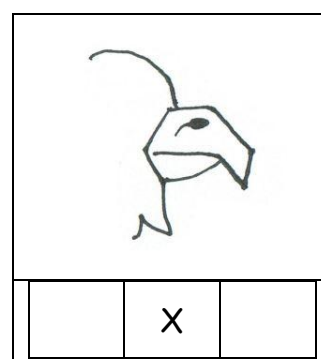
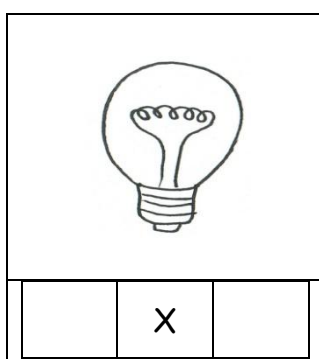
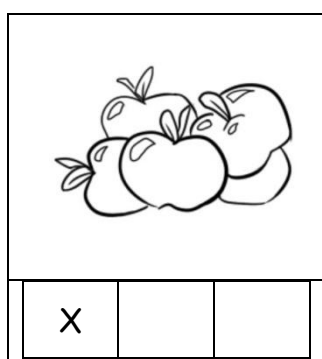

Find Ø lyden

Sig ordet.

Lyt til Ø lyden.

Sæt kryds ved Ø lyden i begyndelsen, i midten eller til sidst i ordet.

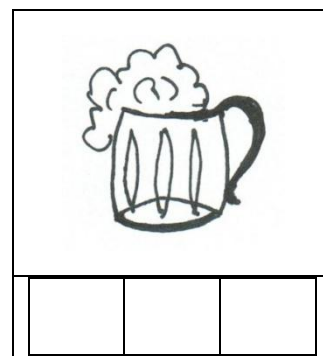
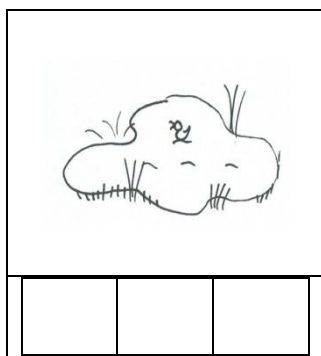
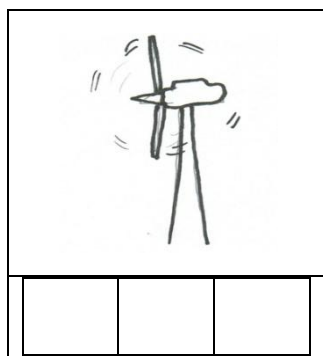
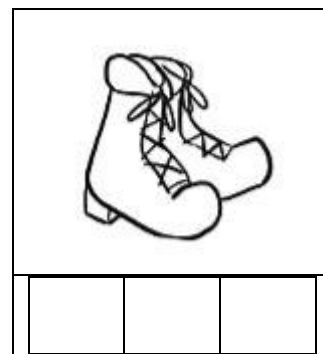
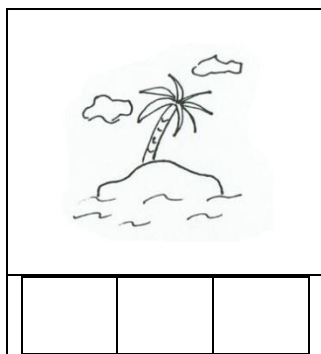
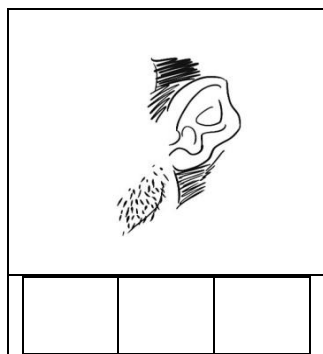
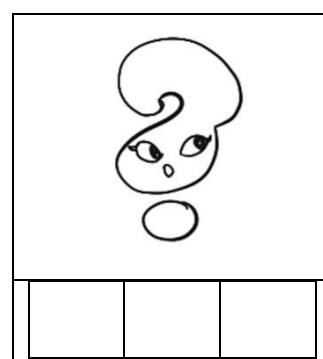
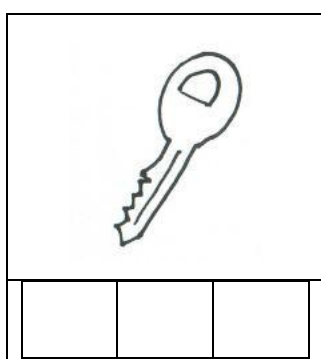

Find Ø lyden **LØSNING**

Sig ordet.

Lyt til Ø lyden.

Sæt kryds ved Ø lyden i begyndelsen, i midten eller til sidst i ordet.

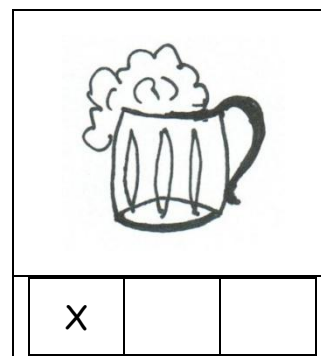
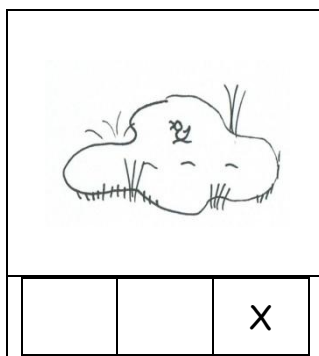
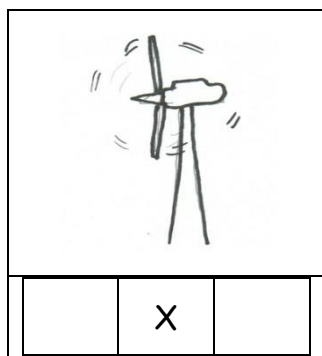
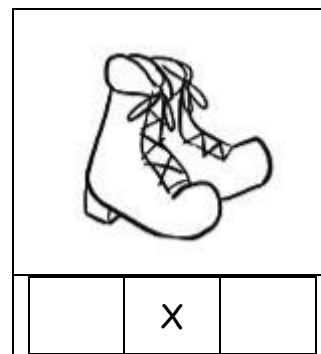
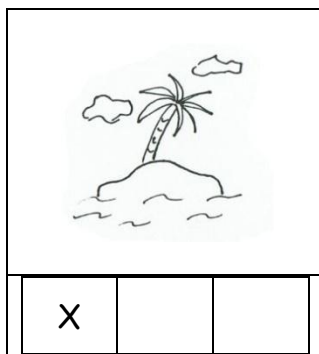
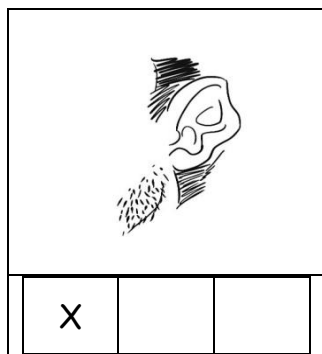
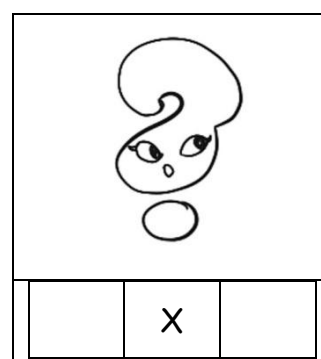
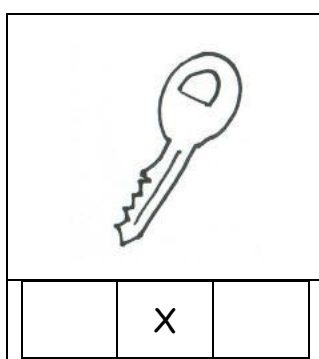
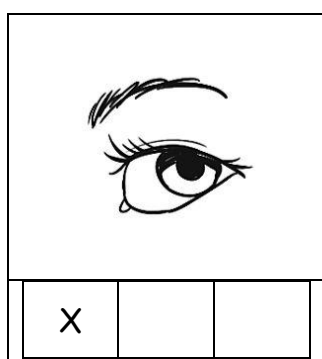

Find Å lyden

Sig ordet.

Lyt til Å lyden.

Sæt kryds ved Å lyden i begyndelsen, i midten eller til sidst i ordet.

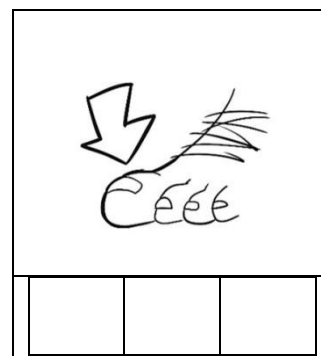
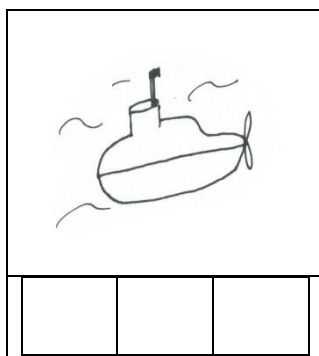
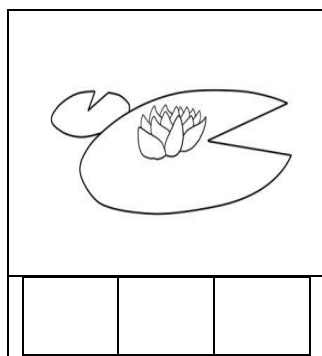
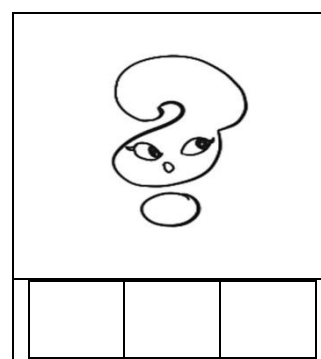
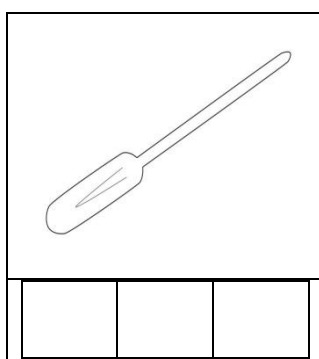
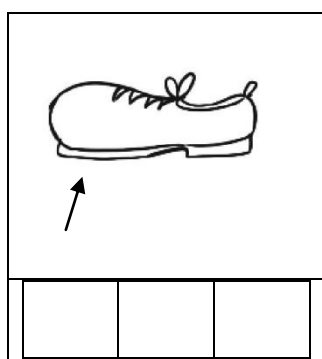
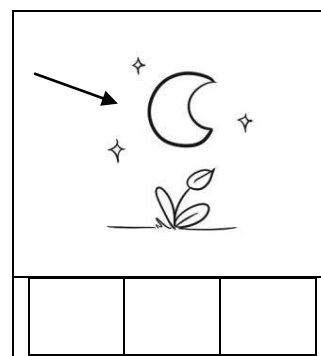
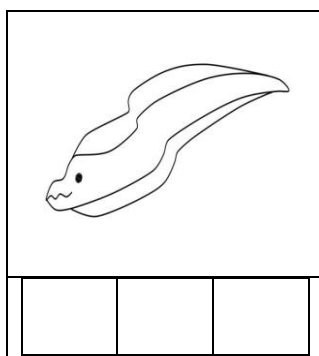
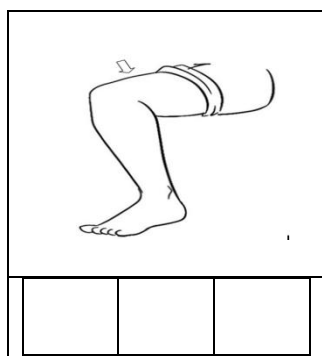

Find Å lyden **LØSNING**

Sig ordet.

Lyt til Å lyden.

Sæt kryds ved Å lyden i begyndelsen, i midten eller til sidst i ordet.

