

## Find C lyden

Sig ordet.

Lyt til C lyden.

Sæt kryds ved C lyden i begyndelsen, i midten eller til sidst i ordet.

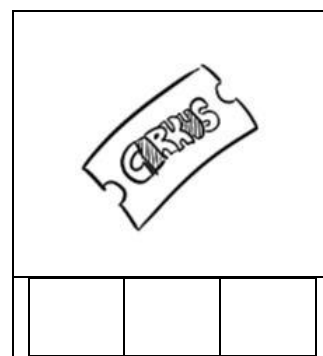
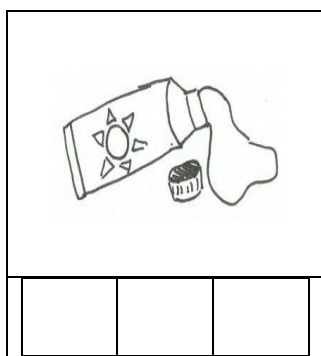
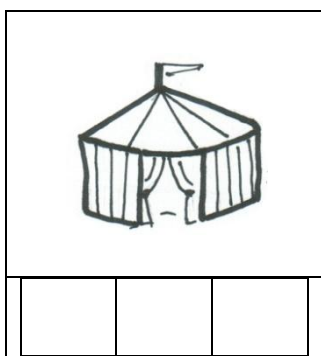
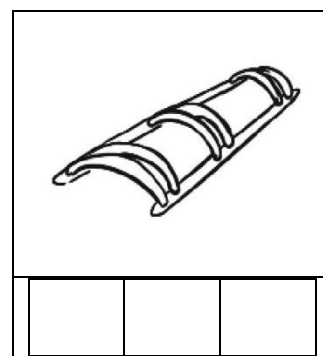
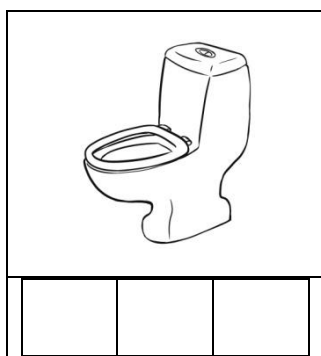
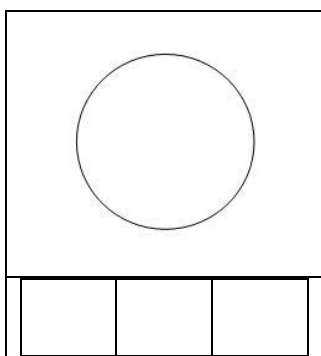
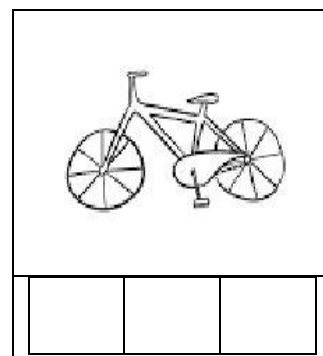
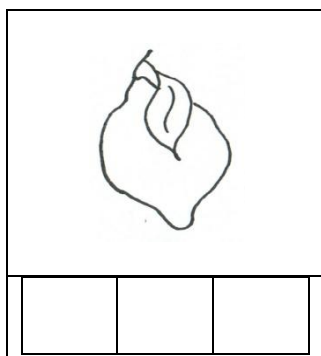
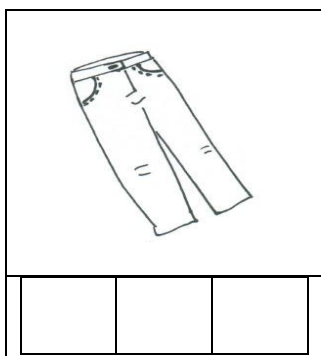



Find **C** lyden **LØSNING**

Sig ordet.

Lyt til **C** lyden.

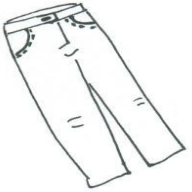
Sæt kryds ved a lyden i begyndelsen, i midten eller til sidst i ordet.

		
X		

		
X		

		
X		

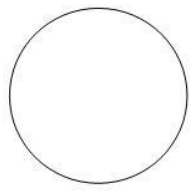
		
X		

		
		X

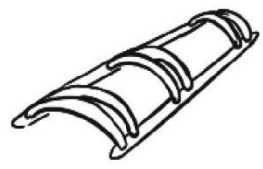
		
X		

		
X		

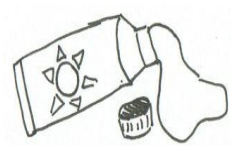
		
X	X	

		
X		

CREAM

SOLDREAM