

Find J lyden

Sig ordet.

Lyt til J lyden.

Sæt kryds ved J lyden i begyndelsen, i midten eller til sidst i ordet.

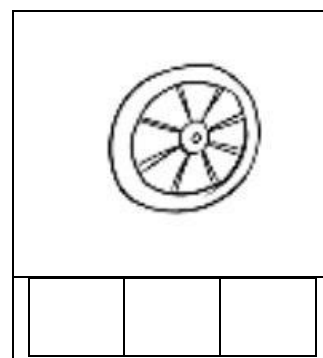
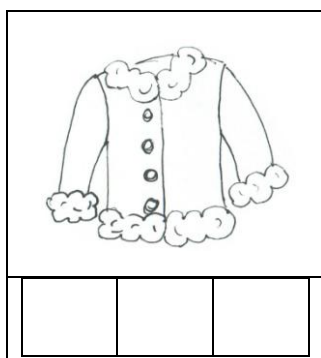
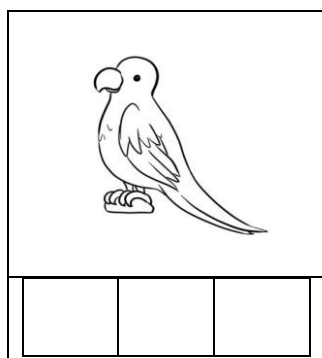
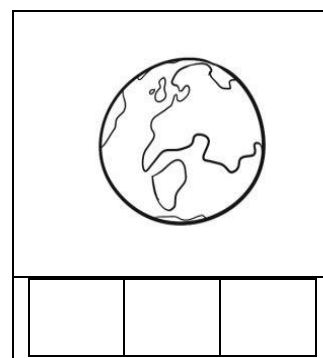
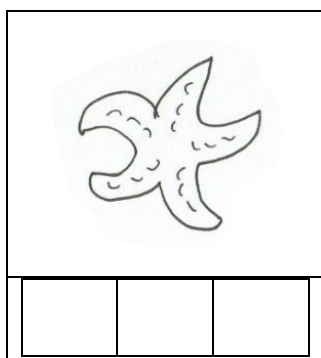
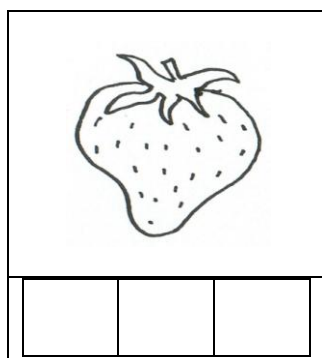
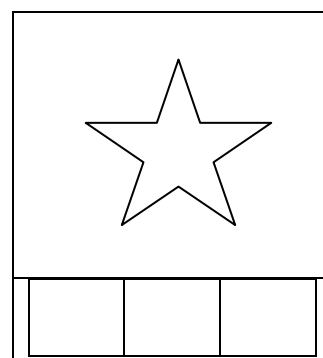
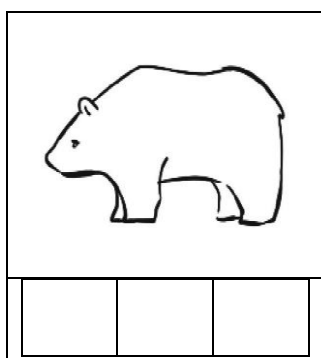
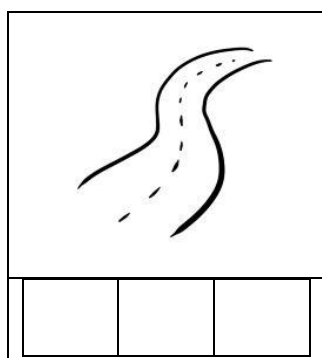

Find J lyden **LØSNING**

Sig ordet.

Lyt til J lyden.

Sæt kryds ved J lyden i begyndelsen, i midten eller til sidst i ordet.

