

Find H lyden

Sig ordet.

Lyt til H lyden.

Sæt kryds ved H lyden i begyndelsen, i midten eller til sidst i ordet.

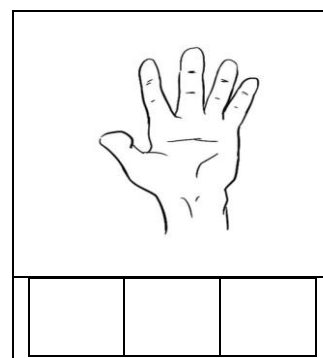
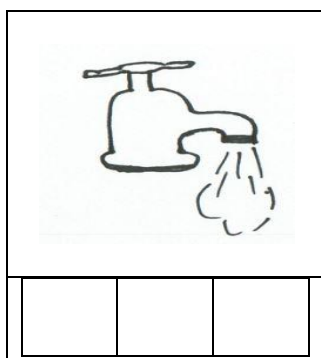
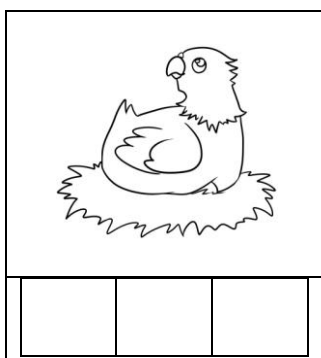
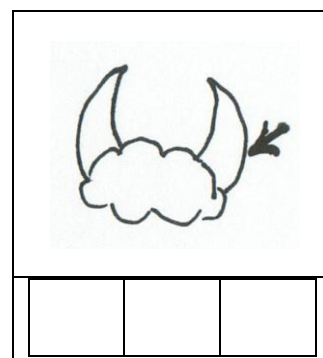
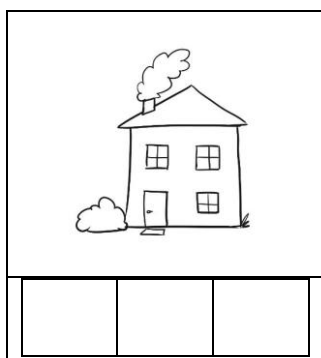
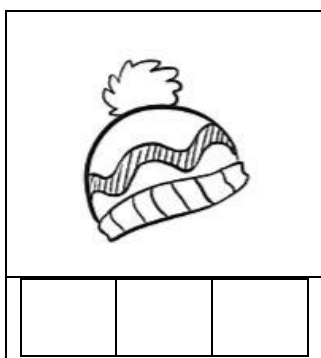
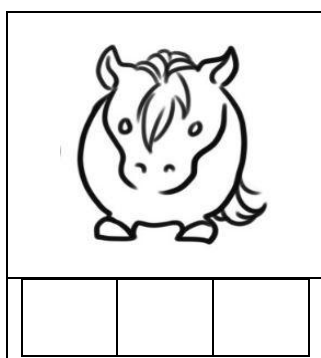
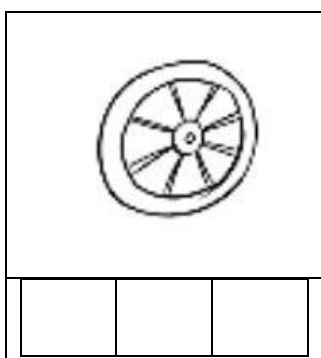

Find H lyden **LØSNING**

Sig ordet.

Lyt til H lyden.

Sæt kryds ved H lyden i begyndelsen, i midten eller til sidst i ordet.

