

Find C lyden

Sig ordet.

Lyt til C lyden.

Sæt kryds ved C lyden i begyndelsen, i midten eller til sidst i ordet.

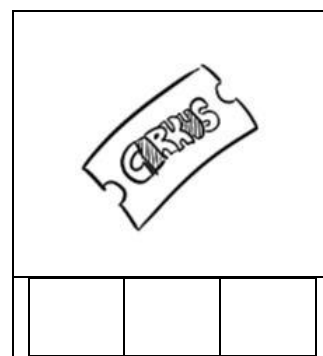
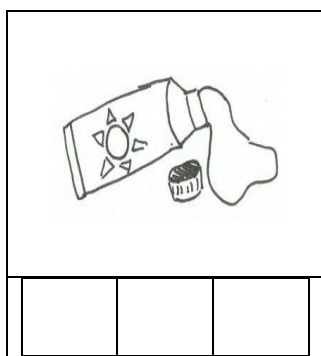
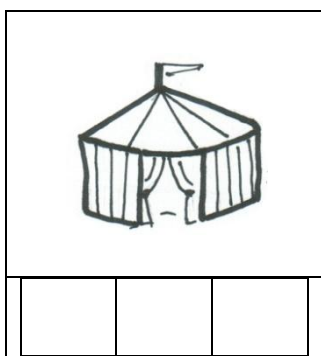
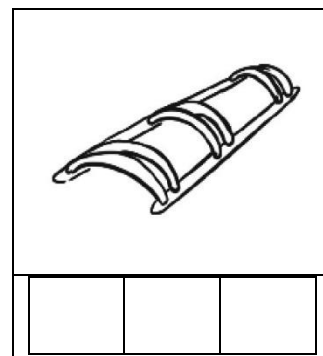
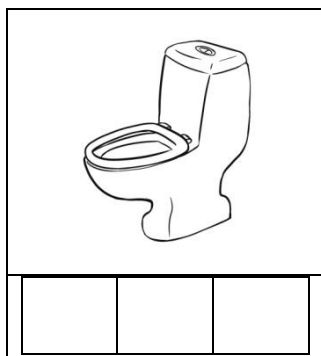
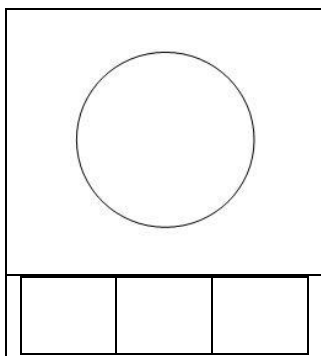
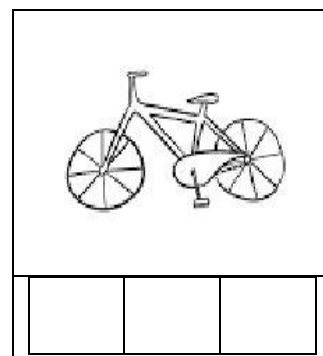
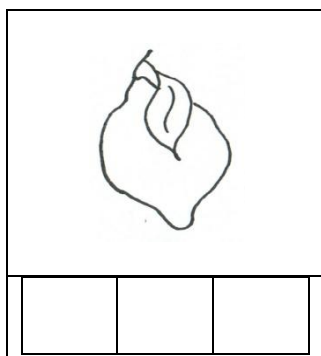
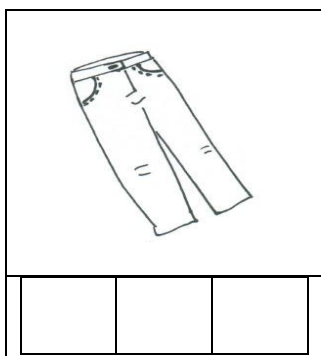

Find C lyden **LØSNING**

Sig ordet.

Lyt til C lyden.

Sæt kryds ved a lyden i begyndelsen, i midten eller til sidst i ordet.

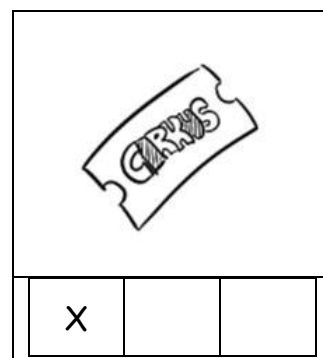
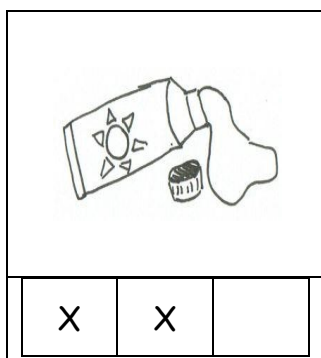
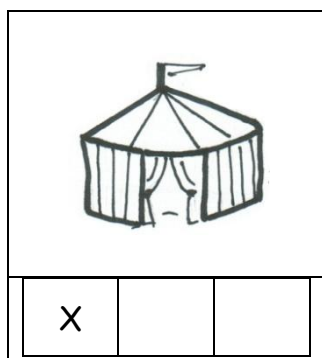
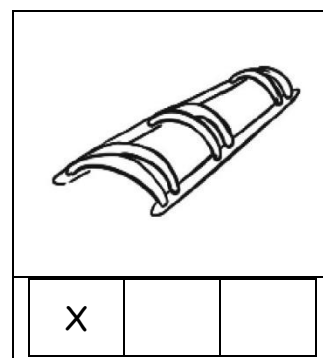
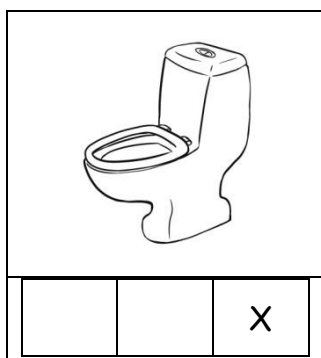
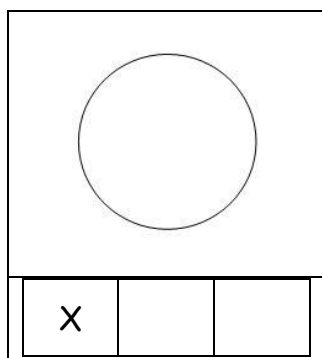
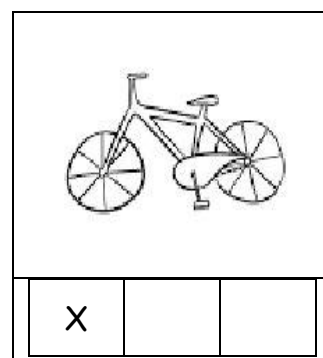
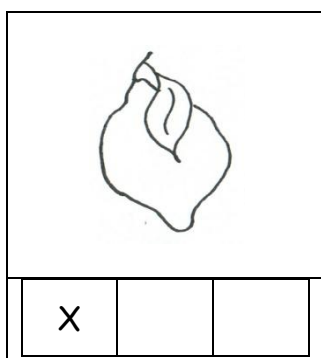
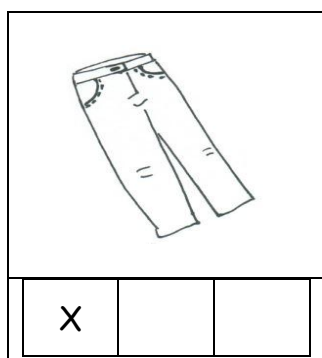

CREAM

SOLDREAM